

13. – 16. 3. 2014

Das Organisationskomitee freut sich die Mitgliederverbände des Internationalen Ski Verbandes (FIS) für FIS WCH Ski Fliegen 2014 in Harrachov einzuladen.

The Organizing Committee takes a pleasure to invite all member Associations of the International Ski Federation (FIS) for the FIS Ski Flying World Championships Harrachov 2014.



[harrachov2014.cz](http://harrachov2014.cz)

Presenting Partner



Officials Partners



Media Partner



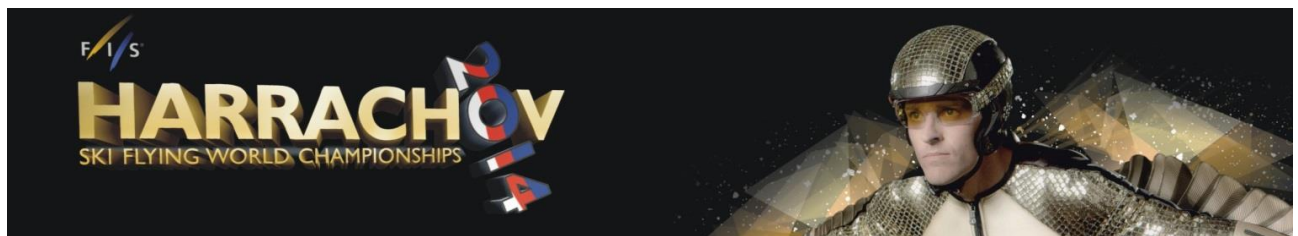

**Veranstalter/Organizer:** Tschechischer Skiverband/  
Czech Ski Association

**Realisierung/Realization:** **CS SKI, s.r.o.**

**Bestimmungen/Rules:** IWO – ICR, FIS Reglement

**Termin/Date:** **13. – 16.03.2014**

**Ort/Venue:** adidas arena harrachov; Čerťák, HS 205

**Meldungen/Entries:**

WHEN	WHAT	WHO
13 <sup>th</sup> December 2013 (3 months before)	Preliminary Team Entry	National Ski Association
20 <sup>th</sup> February 2014 (21 days before)	Provisional Team Selection	National Ski Association
10 <sup>th</sup> March 2014 (24 hours after the last World Cup in Oslo)	Final Team Selection	National Ski Association
13 <sup>th</sup> March 2014 (2 hours before draw)	Definite Entries	National Ski Association/ Team Captain

Ab 13.12.2013 wird ein On-line System für Registration, Unterkunft, Transport usw. im Betrieb. Alle Info erhalten alle Mannschaften rechtzeitig bis 13.12.2013. **Anmeldung erst ab 13.12.2013 möglich.**

On the 13<sup>th</sup> December 2013 will be activated the Online system for registration, accommodation, transport, etc. Information about registration will be sent to all teams in advance. **Registration available since 13th December 2013.**

**Haftung/Responsibility:**

Haftungsausschluß des durchführenden Vereins für Schaden und Unfälle jeglicher Art. Auf die Versicherungspflicht wird hingewiesen!

Organizers who carry out the competition are not responsible for all kinds of accidents and damages. We indicate that it is your duty to have insurance.

**[harrachov2014.cz](http://harrachov2014.cz)**

Presenting Partner



Officials Partners



Media Partner



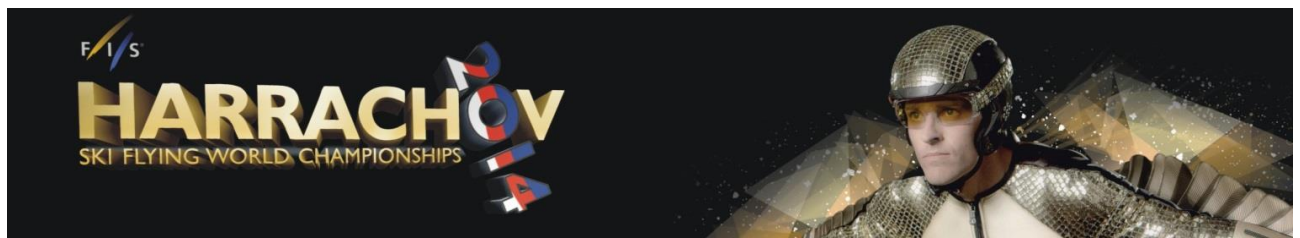

## ORGANIZING COMMITTEE

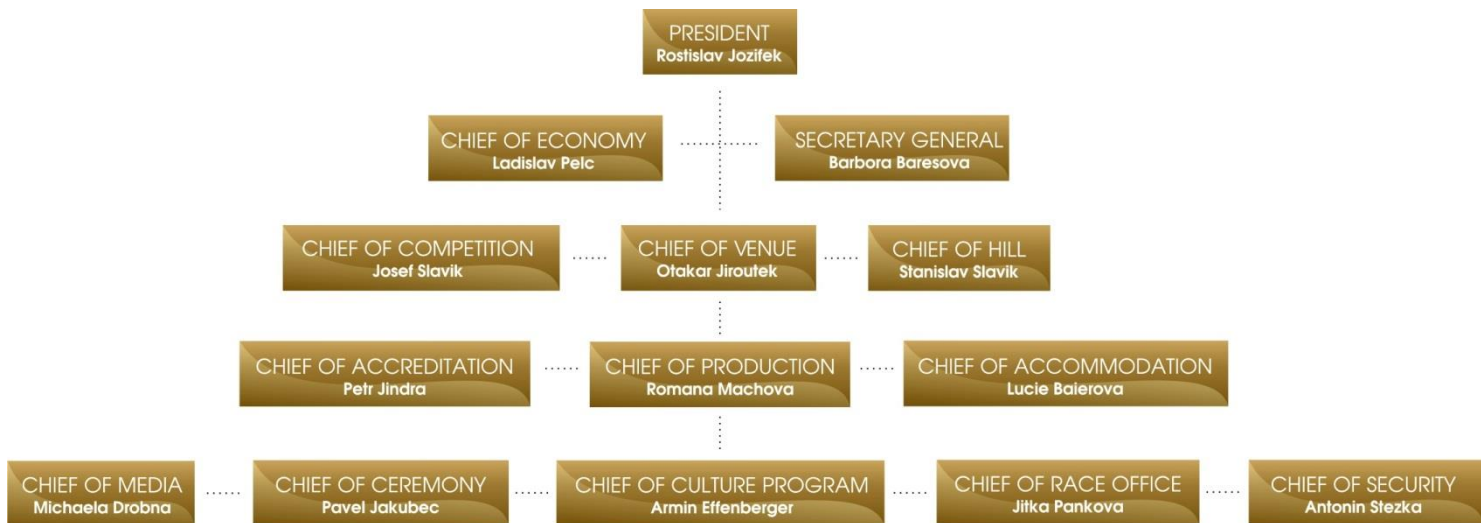

## COMPETITION COMMITTEE

Racedirector  
Racedirector Assistant  
Technical Delegate  
TD – Assistant  
Chief of Measuring  
Chief of Competition

Walter Hofer FIS  
Miran Tepes FIS  
Eero Kuusinen FIN  
Thomas Klauser GER  
Teppo Nieminen FIN  
Josef Slavik CZE

Sprungrichter / Judges:

Danes Raich CZE  
Jarkko Mantila FIN  
Michael Herzig GER  
Yutaka Minemura JPN  
Eduard Suboch RUS  
Anton Justin SLO

Equipment Control  
Technical Support  
Media Coordinator  
Medical Supervisor  
FIS Council Representative

Jouko Toermaenen FIN  
Sepp Gratzner FIS  
Horst Nilgen FIS  
Inggard Lereim NOR  
Roman Kumpost CZE

[harrachov2014.cz](http://harrachov2014.cz)

Presenting Partner



Officials Partners



Media Partner



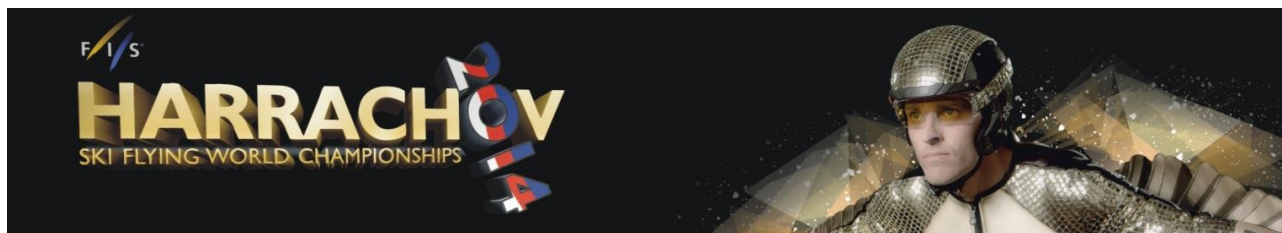

## ZEITPLAN/TIMETABLE:

### Mittwoch/Wednesday | 12.03.2014

Anreise, Unterkunft im Orea Hotel Sklár\*\*\*\*

Arrival of teams, Accommodation - Orea Vital Hotel Sklár\*\*\*\*

20.00 TCM in Congress Hall of Orea Vital Hotel Sklár

### Donnerstag/Thursday | 13.03.2014

14.30 Offizielles Training (2 Durchgänge) / Official Training (2 rounds), HS 205

17.00 Qualifikation / Qualification WCH, HS 205

*anschließend Opening Ceremony/  
afterwards Opening Ceremony*

### Freitag/Friday | 14.03.2014

15.30 Probedurchgang / Trial Round WCH, HS 205

16.30 1. Wertungsdurchgang / 1<sup>st</sup> Round

2. Wertungsdurchgang / 2<sup>nd</sup> Round

### Samstag/Saturday | 15.03.2014

15.00 Probedurchgang / Trial Round WCH, HS 205

16.00 3. Wertungsdurchgang / 3<sup>rd</sup> Round

Finaldurchgang / Final Round

*anschließend Siegerehrung (Platz 1 bis 6)/  
afterwards prize giving ceremony (1. – 6. place)*

### Sonntag/Sunday | 16.03.2014

12.30 Proberdurchgang / Trial Round WCH, HS 205

14.00 1. Wertungsdurchgang / 1<sup>st</sup> Round Teams

Finaldurchgang / Final Round Teams

*anschließend Siegerehrung (Platz 1 bis 3)/  
afterwards prize giving ceremony (1. – 3. place)*

Alle Startzeiten vorbehaltlich der FIS Startzeiten sind, die Zeitverschiebungen möglich sind.

Starting times are determined by the FIS starting coordination officials. Times are subject to change at any time.

[harrachov2014.cz](http://harrachov2014.cz)

Presenting Partner



Officials Partners



Media Partner



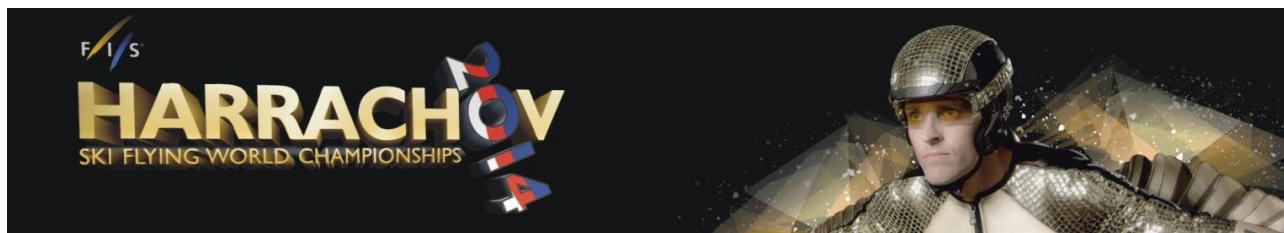

## ANMELDUNG, TRANSPORT, UNTERKUNFT/ENTRY, TRANSPORT, ACCOMMODATION

### Race Office - Pankova Jitka

cell: +420 737 222 483

e-mail: [office@harrachov2014.cz](mailto:office@harrachov2014.cz)

### Transport

e-mail: [transport@harrachov2014.cz](mailto:transport@harrachov2014.cz)

### Accommodation – Lucie Baierova

cell: +420 733 140 037

e-mail: [accommodation@harrachov2014.cz](mailto:accommodation@harrachov2014.cz)

### Accreditation

e-mail: [accreditation@harrachov2014.cz](mailto:accreditation@harrachov2014.cz)

## AKKREDITIERUNG, UNTERKUNFT/ACCREDITATION, ACCOMMODATION

Akkreditierung/Accreditation: Hotel Svornost – 100 m vom/from Hotel Sklar

Unterkunft/Accommodation: Orea Vital Hotel Sklar\*\*\*\*

**WICHTIG:** Gleich beim Anknunft zuerst zu der Akkreditierung bitte kommen wo bekommt man den Voucher für die Unterkunft vom Hotel!

**IMPORTANT:** Directly after arrival visit an Accreditation Office and pick up a voucher for accommodation!



[harrachov2014.cz](http://harrachov2014.cz)

Presenting Partner



Officials Partners



Media Partner



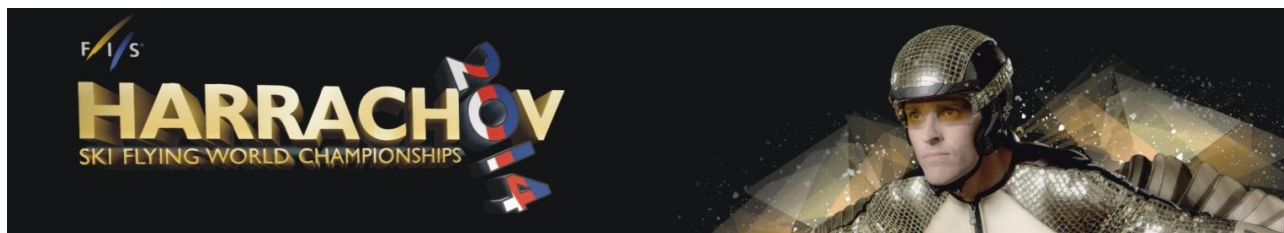

## RENNBÜRO/RACE OFFICE

### Hotel SVORNOST

Mittwoch/Wednesday	12.03.2014	10.00 - 22.00
Donnerstag/Thursday	13.03.2014	08.00 - 22.00
Freitag/ Friday	14.03.2014	08.00 - 22.00
Samstag/Saturday	15.03.2014	08.00 - 22.00
Sonntag/Sunday	16.03.2014	07.00 - 18.00

## AKKREDITIERUNG/ACCREDITATION

### Hotel SVORNOST

Mittwoch/Wednesday	12.03.2014	10.00 - 22.00
Donnerstag/Thursday	13.03.2014	08.00 - 22.00
Freitag/ Friday	14.03.2014	08.00 - 22.00
Samstag/Saturday	15.03.2014	08.00 - 22.00
Sonntag/Sunday	16.03.2014	07.00 - 14.00

## TRANSPORT/TRANSFER

Der Transfer vom Flughafen PRAHA nach Harrachov vom LOK organisiert wird und die Kosten auch übernommen werden. Es gilt NUR für die Mannschaften, KEINE Einzelpersonen. Die Einzelpersonen werden nur gegen Aufpreis transportiert.

The transfer from the PRAGUE airport to Harrachov will be organized by LOC and will be paid ONLY to teams, NO single persons. Single persons will be charged additional fee.



[harrachov2014.cz](http://harrachov2014.cz)

Presenting Partner



Officials Partners



Media Partner



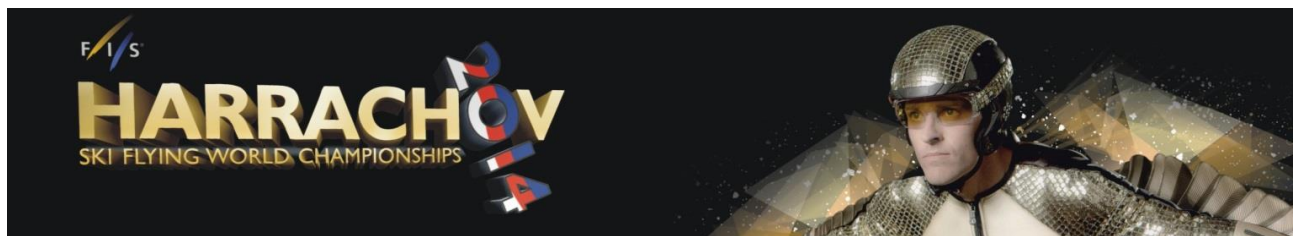

## UNTERKUNFT/ACCOMMODATION



Die mit der namentlichen Meldung bestellten Zimmer gelten als gebucht. Bei nicht erfolgter Abmeldung bis 20. Februar 2014 haftet der nationale Verband für die Kosten.

Alle Kosten, die mit den Athleten verbunden sind, werden laut FIS Reglement berechnet.

All rooms reserved through FIS online system are automatically confirmed. In case of any cancellations till 20<sup>th</sup> February 2014, all expenses will be charged.

The payment of costs for athletes will be according to the FIS rules. All entries have to follow the rules for the organization of FIS World Ski Championships, Article 13.

[harrachov2014.cz](http://harrachov2014.cz)

Presenting Partner



Officials Partners



Media Partner



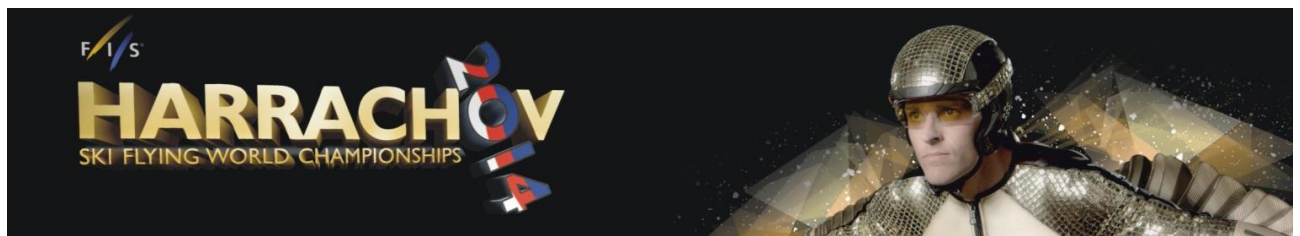

Das Preisgeld laut FIS Reglement werde nur durch die Überweisung ausbezahlt.

Prize money according to the FIS Rules will be paid only to bank accounts.

Für die Elektronische Auszahlung brauchen wir:

**IBAN**

**BIC-code**

**Adresse von der Bank, Bankverbindung**



For electronic payment please fill in the bank information:

**IBAN**

**BIC-code**

**Bank- address**

**Ehrungen/Awards:**

1.- 6. Platz – Pokale/Place – Cup/Individuals

1.- 3. Platz – Pokale/Place – Cup/Teams

Danke, mit sportlichen Grüßen

Best Regards

**Barbora Barešová**

Secretary General - OC Harrachov

cell: +420 739 321 556

e-mail: [barbora.baresova@harrachov2014.cz](mailto:barbora.baresova@harrachov2014.cz)

e-mail: [office@harrachov2014.cz](mailto:office@harrachov2014.cz)

**harrachov2014.cz**

Presenting Partner



Officials Partners



Media Partner







FÉDÉRATION INTERNATIONALE DE SKI  
 INTERNATIONAL SKI FEDERATION  
 INTERNATIONALER SKI - VERBAND



No. FLY VI / CZE 1.Verlängerung  
**CERTIFICATE OF JUMPING HILL**  
**CERTIFICAT DE CONFORMITE**  
**SCHANZENPROFILBESTÄTIGUNG**

Date of issue 05.01 2008 Valid till 31.12.2013  
 Établi le Valable jusqu' au  
 Ausgestellt am Gültig bis

Place: Harrachov Name: Certak

HS = 205 m h/n 0.609 Vo = 28m/s

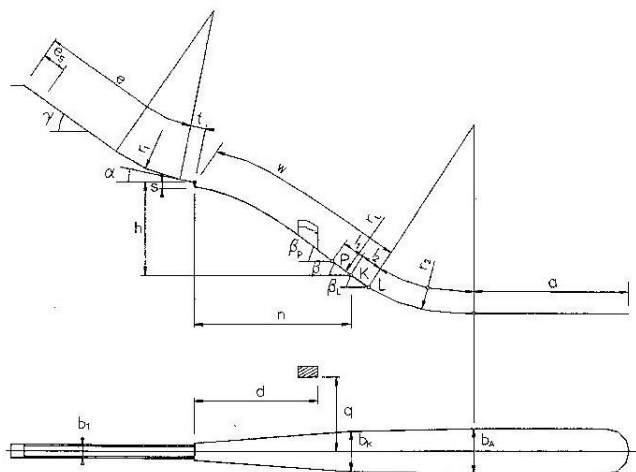

e = 118.5 m	$l_1 = 36.29$ m	P = 148 m
$e_s = 19$ m	$l_2 = 20$ m	K = 185 m
t = 8.0 m	a = 105 m	L = 205 m
$\gamma = 35^\circ$	$\beta_P = 38.5^\circ$	$b_1 = 3$ m
$\alpha = 10.5^\circ$	$\beta = 34.5^\circ$	$b_K = 33.3$ m
$r_1 =$ Kloth.	$\beta_L = 32.3^\circ$	$b_A =$ m
h = 95.69 m	$r_L = 520$ m	d = 115 m
n = 157.25 m	$r_2 = 115$ m	q = 86 m
s = 4.62 m		

JUMPING HILL APPROVED BY THE FIS  
 TREPLIN HOMOLOGUE PAR LA FIS  
 DURCH DIE FIS GENEHMIGTE SPRUNGSCHANZE

SUB-COMMITTEE FOR JUMPING HILLS  
 CHAIRMAN: *Kamuk*

[harrachov2014.cz](http://harrachov2014.cz)

Presenting Partner



Officials Partners



Media Partner

