



fiemme 2014

FIS NORDIC JR & U23
WORLD SKI CHAMPS

Invitation



WELCOME	3
INVITATION	7
ORGANISING COMMITTEE OFFICIALS	9
FIS OFFICIALS	10
PROGRAMME	11
SKI JUMPING STADIUM	15
CROSS COUNTRY STADIUM	17
RULES	22



WELCOME

WELCOME FROM THE PRESIDENT OF THE ORGANISING COMMITTEE - TIZIANO MELLARINI

With the organization of the FIS Nordic World Ski Championships 2013, Val di Fiemme has proved itself once again as land of Nordic disciplines, able to express at the same time a high organizing level and a qualified hospitality system.

Cross country ski is very popular here, in a valley where the environment is the motive force of the local economy, and where eco-sustainability is a value present also in the various accommodation facilities; it is an essential part of a hospitality system inspired by courtesy and quality.

Val di Fiemme is a mountain land where self-government and attention for the environmental heritage are very important aspects of the local community. A tradition which is deep rooted in the centuries, and which finds its foundation in "Magnifica Comunità di Fiemme", an institution which has been guardian of the environmental resources of this land for 900 years.



In this beautiful corner of Trentino it is possible to find many well-advanced courses and infrastructures dedicated to all those people who like cross country ski; all our facilities are surrounded by the unique scenery of the Dolomites, site which is included in the UNESCO World Heritage List.

Now Val di Fiemme is going to organize another great world event, dedicated to the young and promising athletes of Nordic ski, coming from all over the world. FIS Nordic Junior & U23 World Ski Championships represent a new challenge and a positive incentive to offer once again an organizing and logistical level which can keep up with the prestige of this event.

On behalf of the Organizing Committee I want to warmly welcome all the representatives of the Federations present at this sport celebration, all the athletes and their families, the technicians and all the fans of this beautiful discipline.

I wish that your stay in Val di Fiemme allows you to spend some days rich in sport satisfaction, personal improvement and friendship, in the spirit of the universal sport values; I also hope that all of you can bring home a little piece of Trentino, together with a pleasant experience.

Tiziano Mellarini

President of the Organising Committee Trentino Fiemme 2013

Provincial Counselor for agriculture, forests, tourism, promotion, hunting and fishing



SALUTO DA PARTE DEL PRESIDENTE DEL COMITATO ORGANIZZATORE - TIZIANO MELLARINI

La Val di Fiemme, con i Mondiali del 2013, si è confermata ancora una volta terra dello sci nordico, riuscendo ad esprimere al contempo un alto livello organizzativo e un collaudato sistema dell'ospitalità. Qui lo sci di fondo è di casa, in un contesto dove l'ambiente è la forza motore dell'economia locale e dove l'ecosostenibilità è un valore che si ritrova anche nelle tante strutture ricettive, parte integrante di un sistema dell'accoglienza ispirato a cordialità e qualità.

La Valle di Fiemme è un territorio di montagna che ha fatto dell'autogoverno e dell'attenzione al patrimonio ambientale la propria bandiera. Una tradizione radicata nei secoli, che trova il proprio fondamento nella Magnifica Comunità di Fiemme, istituzione che da oltre 900 anni è custode delle risorse ambientali di questa terra.

In questo angolo del Trentino è possibile usufruire di piste e infrastrutture all'avanguardia dedicate agli amanti dello sci di fondo, inserite nello scenario unico delle Dolomiti patrimonio naturale dell'Umanità Unesco.

Ora la Val di Fiemme è chiamata ad accogliere un altro grande evento iridato, dedicato alle nuove leve dello sci nordico internazionale. I Mondiali Junior e Under 23 rappresentano una nuova sfida e un positivo stimolo per mettere in campo ancora una volta un livello organizzativo e una logistica all'altezza del prestigio di questa manifestazione.

A nome mio e del Comitato Organizzatore porgo dunque il più cordiale benvenuto a tutti i responsabili delle Federazioni impegnate in questa festa di sport, agli atleti e alle loro famiglie, ai tecnici e a tutti gli amici appassionati di questa splendida disciplina.

L'auspicio è che il soggiorno in Val di Fiemme possa rappresentare per tutti un momento di soddisfazione agonistica, di arricchimento personale e di amicizia all'insegna dei valori universali dello sport e che ciascuno possa con questa avventura portare con sé un pezzo di Trentino e un'esperienza da ricordare con piacere.

Tiziano Mellarini

Assessore all'agricoltura, foreste, turismo, promozione, caccia e pesca

Provincia Autonoma di Trento

WELCOME FROM THE PRESIDENT OF THE ITALIAN WINTER SPORTS FEDERATION FLAVIO RODA

After the big success of the FIS Nordic World Ski Championships 2013, Val di Fiemme will host next season the Nordic Junior & U23 World Ski Championships, a high level international event, which represents the most important purpose in the whole season for the youngest athletes.

Everybody in the world will have once again the possibility to appreciate the wonderful sceneries of this valley in Trentino; moreover, the numerous athletes and technicians coming from all the participating nations will be able to know one of the greatest organizing committees of sport events that we have in Italy.

The Italian Ski Federation, and obviously all the young Italian athletes of cross country, ski jumping and nordic combined, prepared themselves very carefully, in perfect synergy with the structures that will host this edition of the FIS Nordic Junior & U23 World Ski Championships, in order to get the highest possible result.

For the Italian winter sport environment, this international sport event represents a further goal achieved by Val di Fiemme, and also by the Italian Ski Federation, which works in close contact with the local institutions and with the organizing committee.

I want to thank the authorities, the organizers and volunteers from Trentino and Val di Fiemme, because I am sure that, once again, the Nordic Junior & U23 World Ski Championships will be considered as an example all over the world. I also want to wish good luck to the athletes coming from all the participating nations, so that they can live and make us live some days of great sport performance.

Flavio Roda

President of the Italian Ski Federation



SALUTO DA PARTE DEL PRESIDENTE DELLA FEDERAZIONE ITALIANA SPORT INVERNALI FLAVIO RODA

Dopo il grande successo dell'edizione 2013 dei Campionati del Mondo di Sci Nordico, la Val di Fiemme ospita quest'anno i Mondiali Juniores e Under 23, manifestazione di alto livello internazionale e massimo obiettivo stagionale per gli atleti più giovani.

Gli occhi del mondo avranno ancora una volta l'opportunità di apprezzare gli splendidi scenari di questa vallata del Trentino e i moltissimi atleti e tecnici di tutte le nazionali potranno conoscere da vicino una delle eccellenze italiane in fatto di organizzazione di eventi sportivi.

La Federazione Italiana Sport Invernali, ed in particolare i giovani del fondo, del salto e della combinata nordica, si sono preparati scrupolosamente, ed in perfetta sinergia con le strutture che ospitano questa edizione dei Mondiali Juniores e Under 23, per ottenere il massimo risultato possibile.

Per l'Italia degli sport invernali l'avvenimento agonistico internazionale rappresenta un ulteriore sigillo nell'ampio palmarès della Val di Fiemme e per la stessa F.I.S.I. che lavora a stretto contatto con le Istituzioni locali e con il Comitato organizzatore.

Desidero ringraziare autorità, organizzatori e volontari del Trentino e della Val di Fiemme perché sono certo che, ancora una volta, il Mondiale Juniores e Under 23 sarà portato ad esempio nel mondo, e voglio rivolgere il mio "in bocca al lupo" alle atlete e agli atleti di tutti i Paesi partecipanti, perché vivano e ci facciano vivere giornate di grande spettacolo sportivo.

Flavio Roda (Presidente F.I.S.I.)

INVITATION

On behalf of the International Ski Federation and the Italian Ski Association, the Organizing Committee is please to invite the FIS affiliated associations to participate in the **FIS Nordic Junior World Ski Championships and FIS U23 World Ski Championships Cross Country**, from January 27th. to February 3rd. 2014, in Val di Fiemme.

ORGANIZING COMMITTEE

NORDIC SKI VAL DI FIEMME

Via Regolani, 8

38033 CAVALESE (TN) - ITALY

TEL. +39 0462 352018

FAX +39 0462 352091

E-mail: cristina.bellante@fiemme2013.com

Website: www.fiemmeworldcup.com (dedicated section inside the World Cup site)



COMITATO PER LA PROMOZIONE DELLO SCI IN VAL DI FIEMME
 ISTITUZIONI PUBBLICHE E COMUNI - APT- MAGNIFICA COMUNITA' DI FIEMME - FIS - F.I.S.I. - EBU - P.A.T. - ASSOCIAZIONI DI IMPRESE

NORDIC SKI VAL FIEMME - SRL

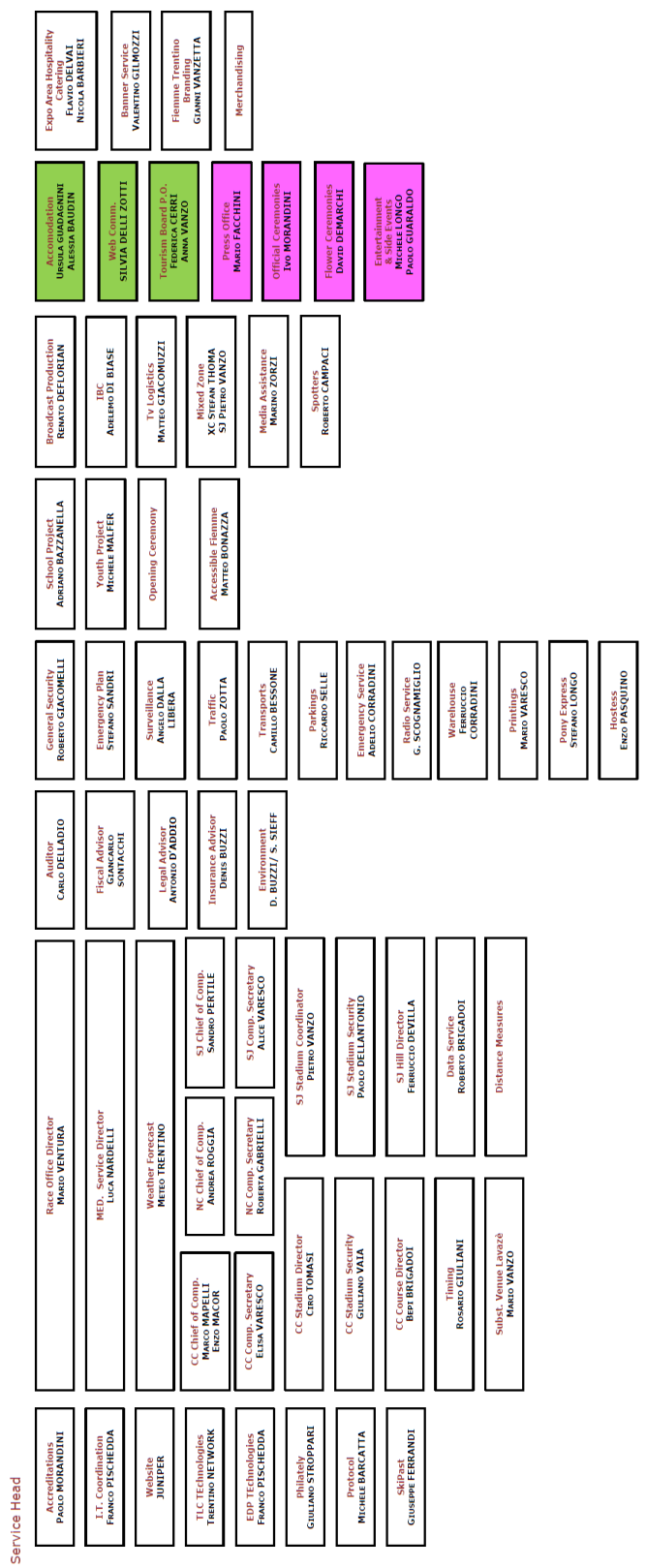
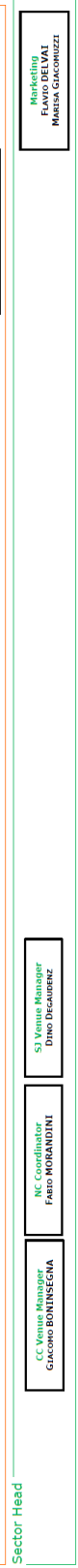
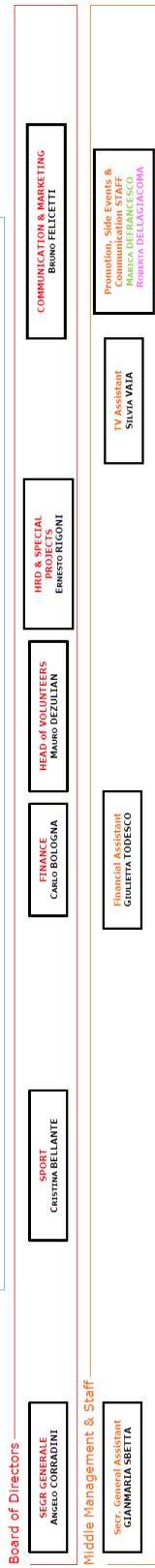
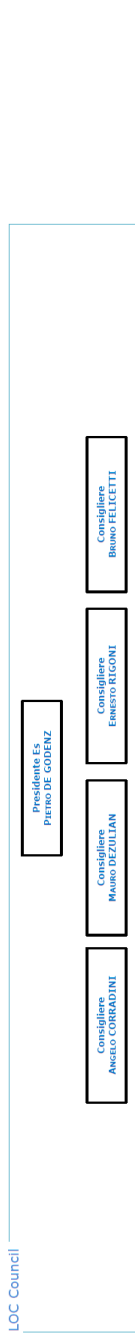

ORGANISING COMMITTEE OFFICIALS

Cross-Country

Chief of Competition	ENZO MACOR
Ass. Chief of Competition	LUIGI GIRARDI
Race Secretary	ELISA VARESCO
Chief of Course	GIUSEPPE BRIGADOI
Chief of Stadium	CIRO TOMASI

Ski Jumping

Chief of Competition	SANDRO PERTILE
Ass. Chief of Competition	PIETRO VANZO
Race Secretary	ALICE VARESCO
Chief of Hill	FERRUCCIO DEVILLA

Nordic Combined

Chief of Competition	ANDREA ROGGIA
Ass. Chief of Competition	FABIO MORANDINI
Race Secretary	ROBERTA GABRIELLI
Chief of Hill	FERRUCCIO DEVILLA
Chief of Course	GIUSEPPE BRIGADOI



FIS OFFICIALS

CROSS-COUNTRY

FIS Coordinator /Press & Media Coordinator	Michal Lamplot (FIS)
Technical Delegate	Tomas Jons (SWE)
TD Assistant	Marko Lustrek (SLO)
Jury Members	

SKI JUMPING

FIS Coordinator/Equipment Control M	Horst Tielmann (FIS)
Technical Delegate	Frank Salvi (FRA)
TD Assistant	Saso Komovec (SLO)
FIS Race Director Ladies	Chika Yoshida (FIS)
Ladies Coordinator/Equipment Control L	Aga Baczkowska (FIS)
Chief of Distance Measurer	Fritz Pollhammer (AUT)
Judges	Tiiu Ounila (ITA)
	Stephan Klein (GER)
	Andrej Galica (POL)
	Milos Kern (SLO)
	Ole Walseth (NOR)
	David Amstein (SUI)

NORDIC COMBINED

FIS Coordinator/Equipment Control	Toni Guggemoos (FIS)
Technical Delegate	Tapio Nurmela (NOR)
TD Assistant	Robert Krautgartner (GER)

MEDICAL /ANTIDOPING

Medical Supervisor	TBC
--------------------	-----

PROGRAMME

CROSS COUNTRY

Monday 27 Jan.	14:00- 16:00	Official Training (JWSC)
	17:00	Team Info (JWSC, U23)
Tuesday 28 Jan.	10:00- 12:00	Official Training (JWSC, U23)
	17:00	Team Captains' Meeting (JWSC, U23)
Wednesday 29 Jan.	10:00	Sprint L/M (F) Qualification (JWSC, U23)
	12:00	Sprint L/M (F) Final (JWSC, U23)
	17:00	Team Captains' Meeting (U23)
Thursday 30 Jan.	10:00	Ladies 10 km (C) (U23)
	11:30	Men 15 km (C) (U23)
	15:30-16:30	Official Training (JWSC)
	17.00	Team Captains' Meeting (JWSC)
Friday 31 Jan.	10:00	Skiathlon Ladies (5C/5F) (JWSC)
	11:30	Skiathlon Men (10C/10F)) (JWSC)
	15:30-16:30	Official Training (U23)
	17:00	Team Captains' Meeting (U23)
Saturday 1 Feb.	10:00	Skiathlon Ladies (7,5C/7,5F) (U23)
	11:30	Skiathlon Men (15C/15F)) (U23)
	15:30-16:30	Official Training (JWSC)
	17:00	Team Captains' Meeting (JWSC)
Sunday 2 Feb.	10:00	Ladies 5 km (C) (JWSC)
	11:30	Men 10 km (C) (JWSC)
	17:00	Team Captains' Meeting (JWSC)
Monday 3 Feb.	10:00	Relay Ladies 4 x 3,3 km (C/F) (JWSC)
	12:00	Relay Men 4 x 5 km (C/F) (JWSC)



SKI JUMPING



Monday 27 Jan.	8:30	Team Info & Captains' Meeting (Ladies)
	10:00	Official Training HS 106 (Ladies)
	17:00	Official Training HS 106 (Ladies)
	18.30	Team Captains' Meeting (Ladies)
	19:00	Team Info & Captains' Meeting (Men)
Tuesday 28 Jan.	16:00	Trial Round HS 106 Individual (Ladies)
	17:00	Competition HS 106 Individual (Ladies)
	20:00	Official Training HS 106 (Men)
Wednesday 29 Jan.	16:00	Official Training HS 106 (Ladies)
	Follows	Team Captains' Meeting (Ladies)
	18:00	Official Training HS 106 (Men)
	follows	Team Captains' Meeting (Men)
Thursday 30 Jan.	8:00	Trial Round HS 106 Team (Ladies)
	8:45	Competition HS 106 Team (Ladies)
	Follows	Official Prize Giving Ceremony (SJ stadium)
	17:00	Trial Round HS 106 Individual (Men)
	18:00	Competition HS 106 Individual (Men)
Friday 31 Jan.	18:00	Official Training HS 106 (Men)
	follows	Team Captains' Meeting (Men)
Saturday 1 Feb.	17:00	Trial Round HS 106 Team (Men)
	18:00	Competition HS 106 Team (Men)
Sunday 2 Feb.	Reserve day for Ski Jumping Men	



NORDIC COMBINED

Monday 27 Jan.	18:00	Team Info & Captains' Meeting (SJ Predazzo)
Tuesday 28 Jan.	10:00	Official Training HS 106 Individual (SJ Predazzo)
	14:30-15:30	Official Training Cross Country (Lago di Tesero)
Wednesday 29 Jan.	10:00	Official Training HS 106 Individual (SJ Predazzo)
	15:30-16:30	Official Training Cross Country (Lago di Tesero)
	18:00	Team Captains' Meeting (SJ Predazzo)
Thursday 30 Jan.	10:30	Trial Round HS 106 Individual Gundersen
	11:30	Competition HS 106 Individual Gundersen
	14:30	Individual 10 km Gundersen
Friday 31 Jan.	10:00	Official Training HS 106 Individual (SJ Predazzo)
	15:30-16:30	Official Training Cross Country (Lago di Tesero)
	18:00	Team Captains' Meeting (SJ Predazzo)
Saturday 1 Feb.	9:00	Trial Round HS 106 Individual Gundersen
	9:50	Competition HS 106 Individual Gundersen
	14:30	Individual 5 km Gundersen
	18:00	Team Captains' Meeting (SJ Predazzo)
Sunday 2 Feb.	9:00	Trial Round HS 106 Team
	9:50	Competition HS 106 Team
	14:30	Team 4 x 5 km
Monday 3 Feb.	Reserve day for Nordic Combined	



CEREMONIES

Monday 27 Jan.	20:30	Opening Ceremony (Main Square Predazzo)
Wednesday 29 Jan.	20:30	Medal Ceremony (Main Square Predazzo) (HS 106 Individual Ladies - Sprint JSWC Ladies/Men - Sprint U23 Ladies/Men)
Thursday 30 Jan.	9:45	Medal Ceremony Team Ski Jumping Ladies On the venue (Ski Jumping Stadium - Predazzo)
Saturday 1 Feb.	20:30	Medal Ceremony (Main Square Predazzo) (10 km Ladies - 15 km Men - HS 106/km 10 Ind. Nordic Combined - HS 106 Ind. SJ Men Skiathlon Ladies JSWC - Skaithlon Men JSWC Skiathlon Ladies U23 - kiathlon Men U23 - HS 106/Ind. 5 km Nordic Combined - HS 106 Ski Jumping Team Men)
Sunday 2 Feb.	13:15	Medal Ceremony - Cross Country stadium - Lago di Tesero (5 km Ladies JSWC - 10 km Men JSWC)
	15:30	Medal Ceremony - Cross Country stadium - Lago di Tesero (Nordic Combined Team HS 106 / 4 x 5 km)
Monday 3 Feb.	13:30	Medal Ceremony and Closing Ceremony Cross Country stadium - Lago di Tesero (Relay Ladies JSWC - Relay Men JSWC)

SKI JUMPING STADIUM



FÉDÉRATION INTERNATIONALE DE SKI
INTERNATIONAL SKI FEDERATION
INTERNATIONALER SKI - VERBAND



No. 285 / ITA 8 1. Verlängerung

CERTIFICATE OF JUMPING HILL
CERTIFICAT DE CONFORMITE
SCHANZENPROFILBESTÄTIGUNG

Date of issue 09.12.2011 Valid till 31.12.2016
Établi le Valable jusqu' au
Ausgestellt am Gültig bis

Place: Predazzo Name: W 95

HS = 106 m h/n = 0.552 Vo = 23.8m/s

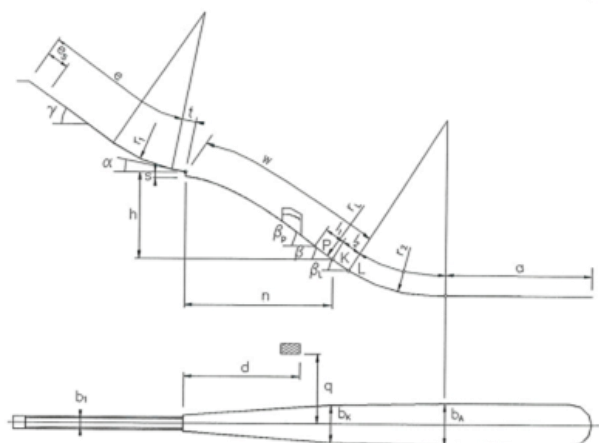

e = 92,58 m	$l_1 = 10,34 \text{ m}$	P = 84,66 m
$e_s = 23,80 \text{ m}$	$l_2 = 10,65 \text{ m}$	K = 95,00 m
t = 6,5 m	a = 100 m	L = 105,65 m
$\gamma = 30^\circ$	$\beta_p = 36,44^\circ$	$b_1 = 2,5 \text{ m}$
$\alpha = 10,5^\circ$	$\beta = 34,99^\circ$	$b_K = 19,00 \text{ m}$
$r_1 = 85,2 \text{ m}$	$\beta_L = 31,4^\circ$	$b_A = 20,90 \text{ m}$
h = 45,56 m	$r_L = 239,82 \text{ m}$	d = 41,00 m
n = 82,66 m	$r_2 = 102 \text{ m}$	q = 22,50 m
s = 2,38 m		

JUMPING HILL APPROVED BY THE FIS
TREPLIN HOMOLOGUE PAR LA FIS
DURCH DIE FIS GENEHMIGTE SPRUNGSCHANZE

SUB-COMMITTEE FOR JUMPING HILLS

CHAIRMAN:

Leamer

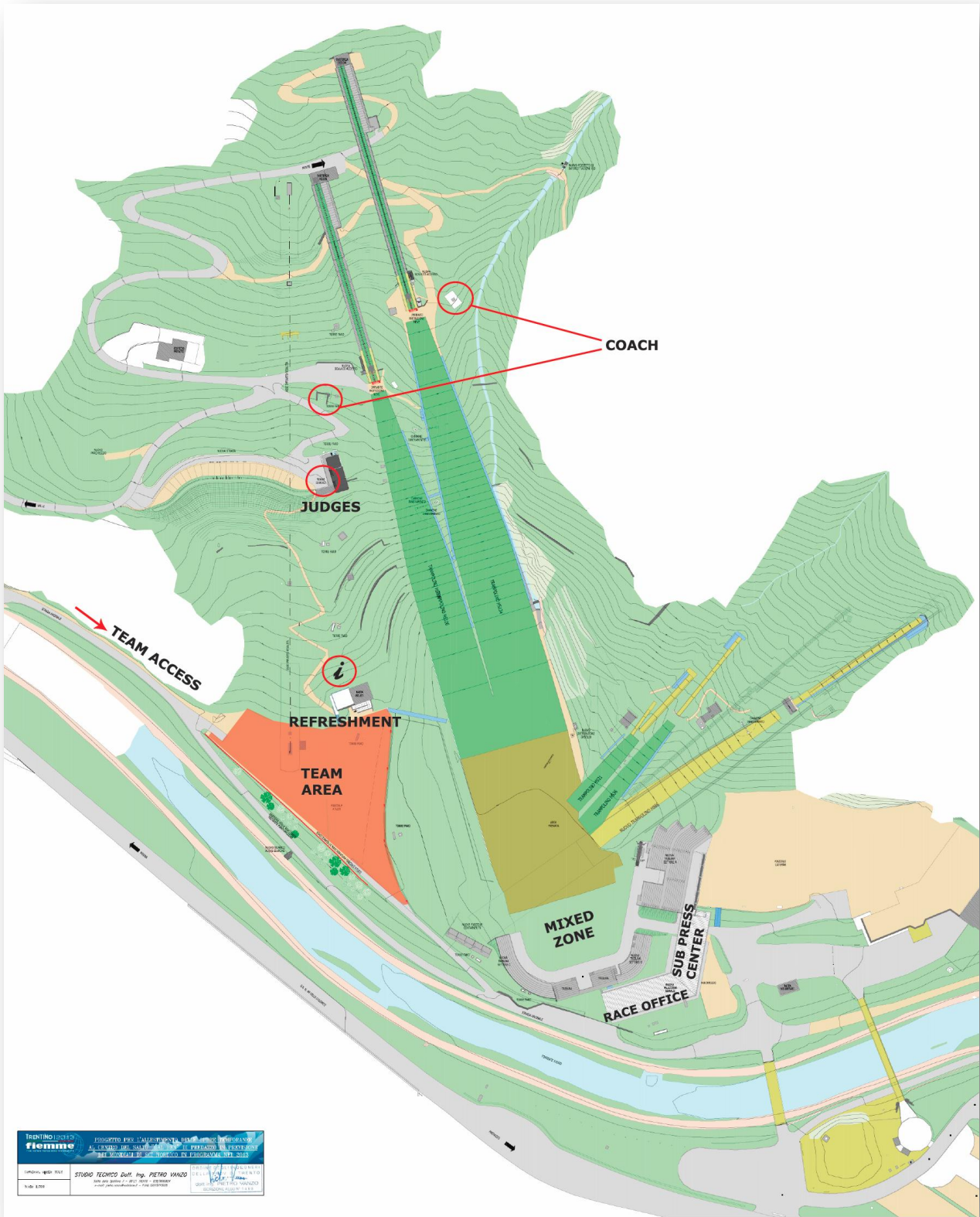

CROSS COUNTRY STADIUM

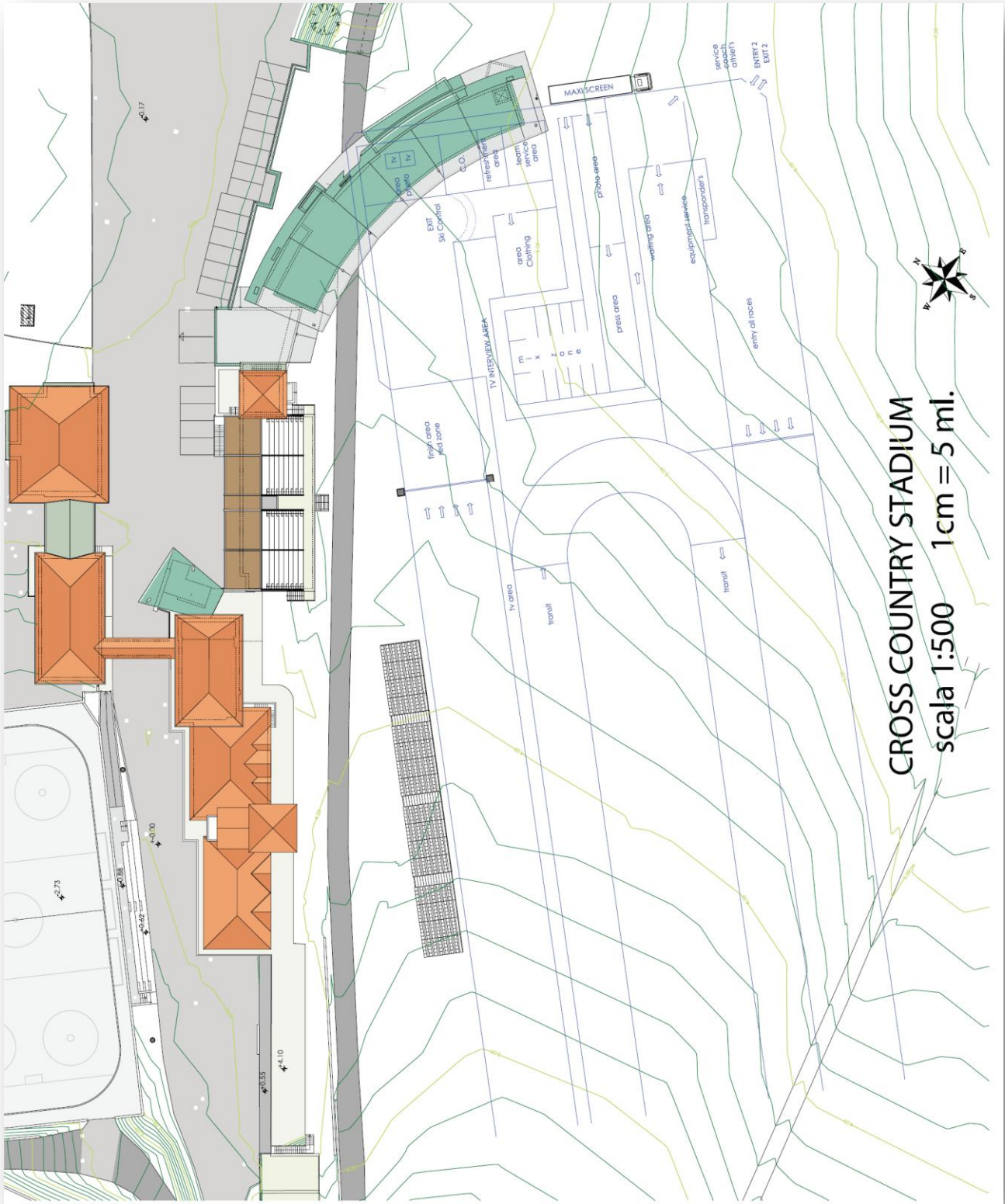

CROSS COUNTRY STADIUM
 scala 1:500 1 cm = 5 m.



XCSprint Ladies 1,2km

Course Length:	1270m	Height Difference (HD):	28m	Lowest Point:	903m
Category:	D	Maximum Climb (MC):	23m	Highest Point:	931m
Competition level:	WSC/FIS	Total Climb (TC):	44m		

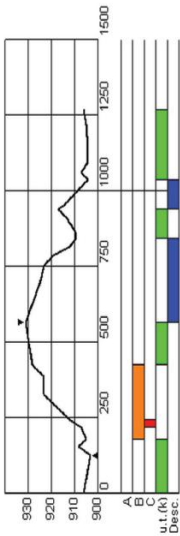

Uphills

- 1 Valena
- 2 Pojer



XCSprint Men 1,5km

Course Length:	1505m	Height Difference (HD):	28m	Lowest Point:	903m
Category:	D	Maximum Climb (MC):	23m	Highest Point:	931m
Competition level:	W S C I F I S	Total Climb (TC):	53m		

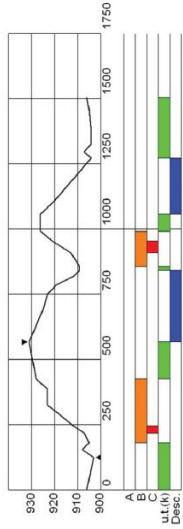

Uphills

- 1 Valena
- 2 Pojer



Uphills

- 1 Valena
- 2 Capol
- 3 Vasche
- 4 Chiesa
- 5 Pojer
- 6 Zorzi

Course Length:	5000m	Height Difference (HD):	60m	Lowest Point:	900m
Category:	C	Maximum Climb (MC):	52m	Highest Point:	960m
Competition level:	WSC/FIS	Total Climb (TC):	190m		



NC 2,5 km

Uphills

- 1 Valena
- 2 Pojer
- 3 Brink
- 4 Zorzi

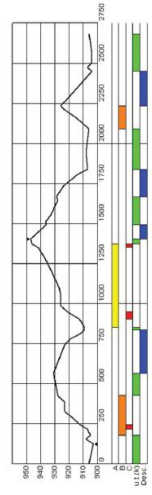

Course Length:	2500m	Height Difference (HD):	44m	Lowest Point:	903m
Category:	E	Maximum Climb (MC):	37m	Highest Point:	947m
Competition level:	W.SCFIS	Total Climb (TC):	96m		



RULES

FIS rules for the FIS Nordic Junior World Ski Championships and FIS U23 World Ski Championships Cross-Country, will apply

http://www.fis-ski.com/data/document/jwsc-u23e-2013_final_inclcover.pdf

ENTRY

5. Right to participate

5.1 All National Ski Associations affiliated to the FIS are entitled to participate.

5.2 To be eligible for participation in the FIS Nordic Junior World Ski Championships and U23 WSC CC the skiers:

- must be a citizen of the country entering him (article 203.5 ICR),
- have a valid FIS Code,
- fulfill any eligibility and qualification criteria laid down in these rules.

6. Number of competitors and officials

Every National Ski Association can send the following maximum number of competitors and officials:

6.1 Junior World Ski Championships

8 Cross-Country competitors Men 4 allowed to start per event

8 Cross-Country competitors Ladies 4 allowed to start per event

5 Ski Jumping competitors Men 4 allowed to start per event

5 Ski Jumping competitors Ladies 4 allowed to start per event

6 Nordic Combined competitors 4 allowed to start per event.

In all national team may thus comprise maximum 32 competitors.

If participating in one discipline: 6 Officials

If participating in two disciplines: 12 Officials

If participating in three or four disciplines: 18 Officials

If participating in all disciplines: 20 Officials

6.2 U 23 World Ski Championships Cross-Country

6 Men Cross-Country 4 allowed to start per event

6 Ladies Cross-Country 4 allowed to start per event

8 Officials if participating in all disciplines

4 Officials if participating only in one discipline (Ladies or Men)

6.3 Quota System for Ski Jumping competitors Men

Athletes Quota: 80 (maximum quota)

NSA Quota: up to 5 per NSA (as a maximum)

4 allowed to start per event

Qualification System

Basic Quota: Each participating NSA is allowed to enter up to two athletes in Ski Jumping men.

Host Nation: The host nation is expected to enter (a) competitor(s) up to the maximum NSA quota of 5.

Allocation of Quotas: The allocation of additional quotas per NSA is based on the COC Ranking List (CRL) composed of the results of the past and current seasons. The allocation

will be made by assigning one quota place per competitor from the top of the standings downwards.



Once a NSA has achieved the maximum number of 5 quota places, the next eligible NSA on the CRL will be allocated a place until the total of 80 competitors is reached (including host nation).

If the number of 80 cannot be reached with the CRL, the FIS CUP standings composed of the results of the last and current season will be taken into consideration.

Process and Timeline: The final quotas based on entries (see art. 10.3) and

using the CRL resp. FIS Cup standings will be calculated and announced after 13th January 2014 prior to the JWSC.

7. Age limits

The FIS competition year is 1st July - 30th June of the following year.

In order to compete in international competitions a competitor must have reached his 16th birthday before the end of the calendar year (1st January - 31st December) in question.

Nordic Junior World Ski Championships

Season Age Years of birth

2013/14 (16-20): 1994, 1995, 1996, 1997, 1998

U23 World Ski Championships Cross-Country

Season Age Years of birth

2013/14 (21-23): 1991, 1992, 1993

10.2 Provisional team selection

December 15th. each National Ski Association must send to the Organizing Committee the provisional team selection with the maximum number of competitors, coaches and service staff according to 6.1.

Teams must use the FIS online registration system "The same system like in the FIS Cross-Country World Cup".

(If you do not have access to the FIS online registration system please contact Judith Lessing : lessing@fisski.com. For questions you can also contact Michal Lamplot: lamplot@fisski.com)

10.3 Final team entry

January 17th. final team entry stating the names, birth dates and FIS Codes as well as the names of the officials (see article 6.1)

Teams must use the FIS online registration system "The same system like in the FIS Cross-Country World Cup".

ACCOMMODATION

Teams/athletes will be accommodated in hotels *** (or ** on request if available) of a good standard in the villages of Val di Fiemme, from 5 to max 20 minutes by car from the venues.

The LOC has a good cooperation with the hotels and can assure an adequate accommodation especially adjusted to the needs of the athletes and teams.

The hotels are adapted to the needs of the athletes, especially regarding the selection of food and times for meals served at the hotel. Three meals (breakfast, lunch, dinner) per day will be served at the hotel, with a sufficient quantity of food and 1 soft drink per meal.

IMPORTANT: hotels accept arrivals not before Monday 27th January, just Ski Jumping Ladies are allowed to arrive Sunday 26th January, L.O.C. will do its best to accommodate the ladies in the same hotel for the whole period, where not possible, L.O.C. will find an accommodation for the first night in a different hotel.

Prices per person per night in double room with full board including 1 soft drink per meal:

Hotel *** € 65

Hotel ** € 55 (while rooms last)

Single room/double room single use supplement € 15 per night (accommodation in single rooms will only be possible if accommodation in double rooms is numerically not possible)



Teams must use the FIS online registration system for accommodation reservation.

Contact of Official Incoming Agency:

Booking Center APT Val di Fiemme - Ursula Guadagnini

ursula.guadagnini@visitfiemme.it Tel. +39 0462 341419 - Fax. +39 0462 231621

The LOC won't be responsible for that teams wishing to take care of their own accommodation arrangements.

Deadline for entries

Within 15th December 2013 nr. of double and single rooms and arrival/departure days must be communicated. Please note that O.C. cannot guarantee for rooms or prices after this date.

As soon as The Official Incoming Agency will receive the requests, a detailed offer will be sent to NSA.

Within 17th January 2014 NSA has to specify its final accommodation requests including exact numbers, room types and arrival/departure.

Payment

30% deposit by bank transfer within 15th December 2013

Balance to be settled directly in hotel (as per Italian rules hotels can accept amount of max euro 999,00 in cash)

Cancellation Fee

The final size of the team at least 10 full days before the official Opening Ceremony (size tolerance -/+ 10%). If a NSA changes the figures with more than 10%, the NSA's is obliged to pay the difference between the effective and announced persons (changes to numbers bigger than +/- 10%, no shows)

In case of no show no refund (100% of the reservation has to be paid)

TRANSPORTS

Costs for travel for the participating teams are at the expense of the respective National Ski Associations. Therefore the Organizing Committee will not provide any kind of official transportation except for Doping Control.

The Organizing Committee can help the National Ski Federations to organize transfer from/to the airports - rent of minibus/car: cristina.bellante@fiemme2013.com

AIRPORTS

Distance / Time to drive

Verona: 160 km / 1,5 hour

Innsbruck: 164 km / 1,5 hour

Venice: 220 km / 2 hours

Milano Linate: 280 km / 3 hours

Milano Malpensa: 330 km / 3,5 hours

Munich: 320 km / 3,5 hours

ANTI-DOPING

Anti-Doping Controls and blood testing are compulsory and will be carried out according to the FIS Rules, at the cross country stadium in Lago di Tesero.

RACE OFFICES

Race offices will be at the respective stadiums: for ski jumping in Predazzo and for cross country in Lago di Tesero.

Opening hours:

CROSS COUNTRY - from January 27th. to February 3rd. 8:00 - 13:00;

SKI JUMPING - January 27th. to February 1st. from 8:00 to 20:30

February 2nd. From 8:00 to 12:00



ACCREDITATION OFFICE

The accreditation office will be at the Cross Country stadium in Lago di Tesero from January 27th. to February 3rd.

All National Federations can do the on-line accreditation on the website www.fiemmeworldcup.com starting from November 1st.

Accreditation will be issued with picture. Teams can upload pictures of their team members before.

TRAINING CAMPS

Before the Championships there is no possibility to train on the course because of Marcialonga cross country popular race.

There is a possibility to train on Passo Lavazè 10 km far away from the cross country stadium in Lago di Tesero:

www.centrofondolavaze.com

www.supernordicskipass.it

INSURANCE

All athletes and team officials have to be insured by their own National Ski Association. All participants have to be covered by an adequate insurance policy for medical costs, accidents, injury, illness and civil liability. The Organizing Committee has coverage for third party liability insurance only.