

COUPE DU MONDE SKI DE BOSSES

- From 14 to 18 December 2021 -

alpe*huez x



FREESTYLE SKI
WORLD CUP x



Awad®

Health
Protocol
COVID-19

17 & 18 December 2021

Measures & rules published by the
organization
in agreement with the FFS & FIS

THE HEALTH PROTOCOL

- This guide was created by the French Ski Federation (FFS) and the Local Organizing Committee (LOC) of L'Alpe d'Huez and has been validated by the International Ski Federation (FIS), in compliance with the [FIS Covid-19 guide](#) and French governmental regulations. This will be communicated to all participants in advance of the event.
- It is everyone's responsibility to follow the protocol put in place for the Coupe du Monde de Ski Bosses de L'Alpe d'Huez. If this is not followed, the person concerned will not be able to stay on the event.
- The principles, to date :
 - **Interactions limitation** through sanitary bubbles
 - An airtight racing bubble with very strict protocols
 - Respect for physical distancing and barrier gestures in all areas
 - **Wearing a mask** is mandatory in all interior and exterior areas
 - **A policy of nasopharyngeal or antigenic RT-PCR virological tests** and a **health questionnaire** has been set up for the races, organization and press bubbles
 - Strict compliance with the Ministry of Health and the ARS rules



ENTRY REGULATIONS IN FRANCE

All participants must comply with the latest regulations regarding travel restrictions to and from France.

Please consult :

www.diplomatie.gouv.fr

www.diplomatie.gouv.fr/en/coming-to-france/coronavirus-advice-for-foreign-nationals-in-france/

During your stay in France, download and activate #TousAntiCovid application

<https://bonjour.tousanticovid.gouv.fr/en>



THE SANITARY BUBBLES

In order to facilitate traffic flow and avoid any contact between the various people present, a system of accreditation and access zones by color has been set up.

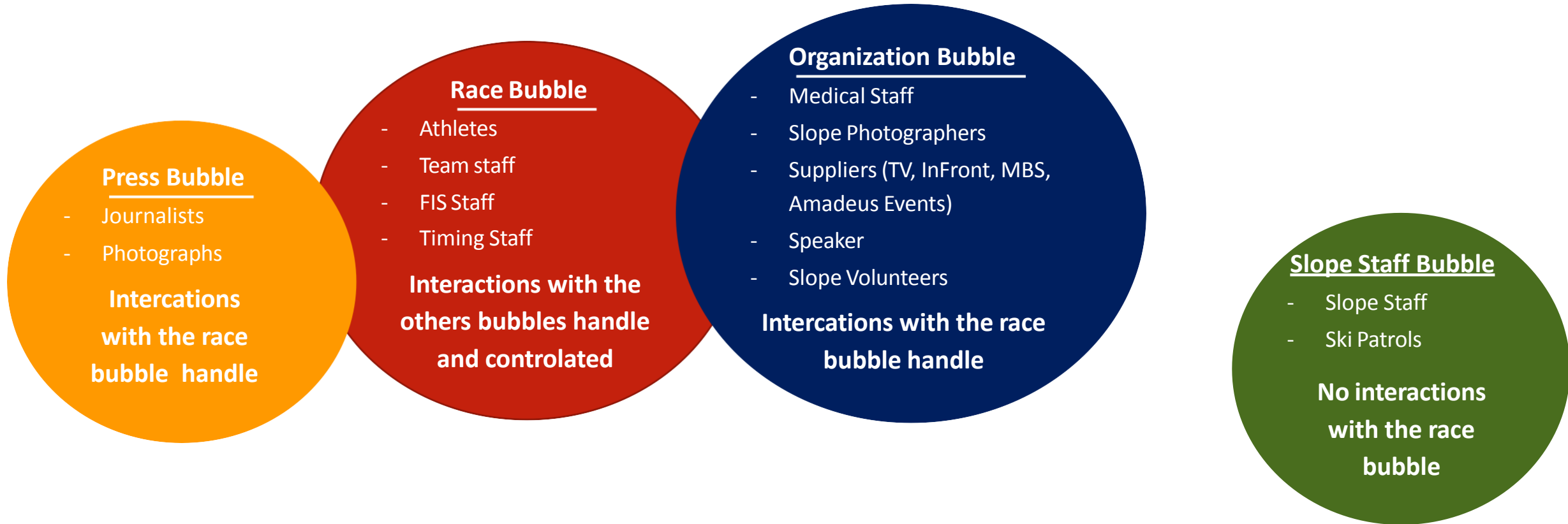

TESTS POLICY

To be accredited, you must to present:

RACE BUBBLE

Cumulative conditions:

- + Valid European Sanitary Pass
- + A nasopharyngeal or antigenic RT-PCR negativ test dated less than 72h before the start of the competition
- + Obligation to present the completed and signed FIS questionnaire

Please complete the FIS passport

-> <https://fispassport.fisSKI.com/fis/>

RACE ORGANIZATION & PRESS BUBBLE

- + Valid European Sanitary Pass
- + Result of :
 - a nasopharyngeal RT-PCR or antigen test < 0 less than 72 hours before the start of the event.
 - Or an RT-PCR or antigen test >0, dated less than 6 months and more than 2 weeks
- + Obligation to present the completed and signed FIS questionnaire

ORGANIZATION, SLOPE STAFF, VIP & PUBLIC BUBBLE

- Valid European Sanitary Pass

EUROPEAN SANITARY PASS =

- Complete updated vaccination status (**Pfizer, Moderna, AstraZeneca, Vaxzevria, Covishield or Johnson & Johnson**)
- OR a negativ RT-PCR or antigen test dated less than 72h
- OR a positiv RT-PCR or antigen test dated less than 6 months and more than 2 weeks

TESTS POLICY

During the event:

RACE BUBBLE

For all participants without a complete updated vaccination status ((Pfizer, Moderna, AstraZeneca, Vaxzevria, Covishield or Johnson & Johnson):

- nasopharyngeal RT-PCR test every 72h

RACE ORGANIZATION & PRESS BUBBLE

For all participants without a complete updated vaccination status ((Pfizer, Moderna, AstraZeneca, Vaxzevria, Covishield or Johnson & Johnson):

- nasopharyngeal RT-PCR test every 72h

ORGANIZATION, SLOPE STAFF, VIP & PUBLIC BUBBLE

- Valid European Sanitary Pass

During the race, you can contact the medical center of Alpe d'Huez or the nurses for doing a RT-PCR (results in 24h) or antigen tests (results on 15min)

After the race, contact the coordinating doctor of Alpe d'Huez for any occurrence of symptoms within 7 days of the Moguls World Cup

PREVENTION DEVICE

- Disinfection solutions in all key places
- The masks or approved buff obligatory (depending of national norm and/or signage in place)
- All working areas should be disinfected and cleaned (TCM Room, Team Area, VIP Space, Press Room, etc...)
- Distanciation requested
- Limited number of people per zone
- Reminders for athletes and spectators: main competition speaker, information, posters, team captains meeting, etc...
- LOC will be always in communication with the medical center of Alpe d'Huez .
- The LOC recommends that you to download the « TousAntiCovid » application

SANITARY MEASURES

OBJECTIVE & BASIC PRINCIPLES

Preserve the health of the athletes and all those involved in the event as well as the continuity of the races.



PROTECTION

Mandatory mask wearing
Regular use of hydroalcoholic gel



DISTANCING

Respect for social distancing



SECURITY

No interaction with the public (autographs and selfies are strictly prohibited)

SANITARY MEASURES

OBJECTIVE & BASIC PRINCIPLES



SCREENING

Subscribe to the Covid-19 testing policy presented above, and in conjunction with the Ministry of Health



CONFINEMENT

Stay within one's sanitary bubble and avoid all unplanned or unsafe outside contact



TRANSPARENCY

Alert the doctors and organizing committee of any symptoms
Identify any contacts at risk



VENTILATION

Ventilated spaces

SANITARY MEASURES

BREACH OF HEALTH PROTOCOL



SANITARY MEASURES

- ✓ Verification of the sanitary pass and the access contrôle according to the accreditation colors will be done at the entrance of the event.
- ✓ The spaces will be reorganized in order to limit the flow of people
- ✓ Limit the workforce within the spaces

Lift Access :

- ✓ Specific queue for the race bubble
- ✓ Respect of the national laws in place during the event : See the ski lifts' rules SATA (Société D'Aménagement Touristique de l'Alpe d'Huez)



SANITARY MEASURES

Podiums :

- ✓ Prize giving at the end of the races on the finish area
- ✓ Respect for physical distancing between the athletes themselves and between athletes and journalists
- ✓ A space will be reserved for photographers and journalists in front of the podium at a suitable distance
- ✓ No handshaking
- ✓ Athletes must stay on their podium

Media :

- ✓ Media will not be able to have direct access to athletes, competition areas or team zones.
Concerning the athletes' interviews, media should do it from the Mixed Zone (through the safety area)
- ✓ It is recommended that journalists invest in a 'selfie stick' or boom stick to get the recording device close enough to pick up the athlete's voice during mixed zone interviews.
- ✓ All microphones should have a plastic cover over the foam that is replaced after each interview. The microphone should stay only with the athlete and the journalist should not speak into it as well



SANITARY MEASURES BY ZONE

FLOW PLAN

Bulle Course :
Athlètes / Staff des équipes / Staff de la FIS / Equipe Timing

Bulle Staff Piste :
Lisseurs / Pisteurs

Bulle Organisation :
Equipe médical / Photographe piste / Prestataires piste / Bénévoles pistes

Bulle Presse :
Journalistes / Photographes

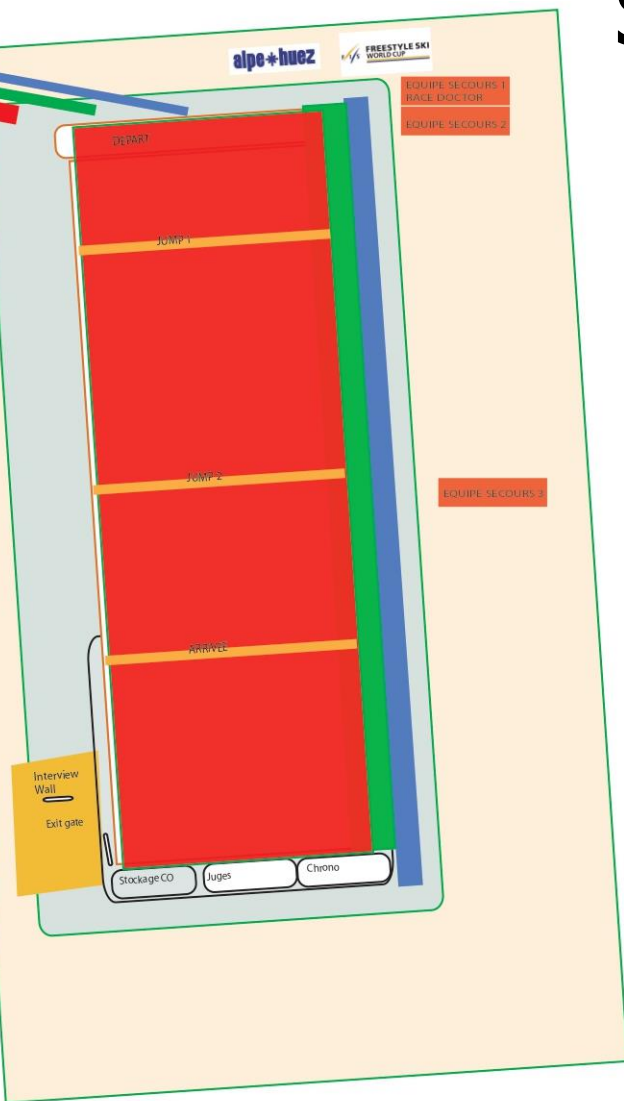

Race bubble :
Athletes / Team staff / FIS Staff / Timing staff

Organization bubble :
Medical staff / slope Photographer / Suppliers / Slope volunteers

Slope staff bubble :
Slope staff / Ski Patrols

Press bubble :
Journalists / Photographs

Salle Antidopage
SATA GROUPE

SANITARY MEASURES BY ZONE

START

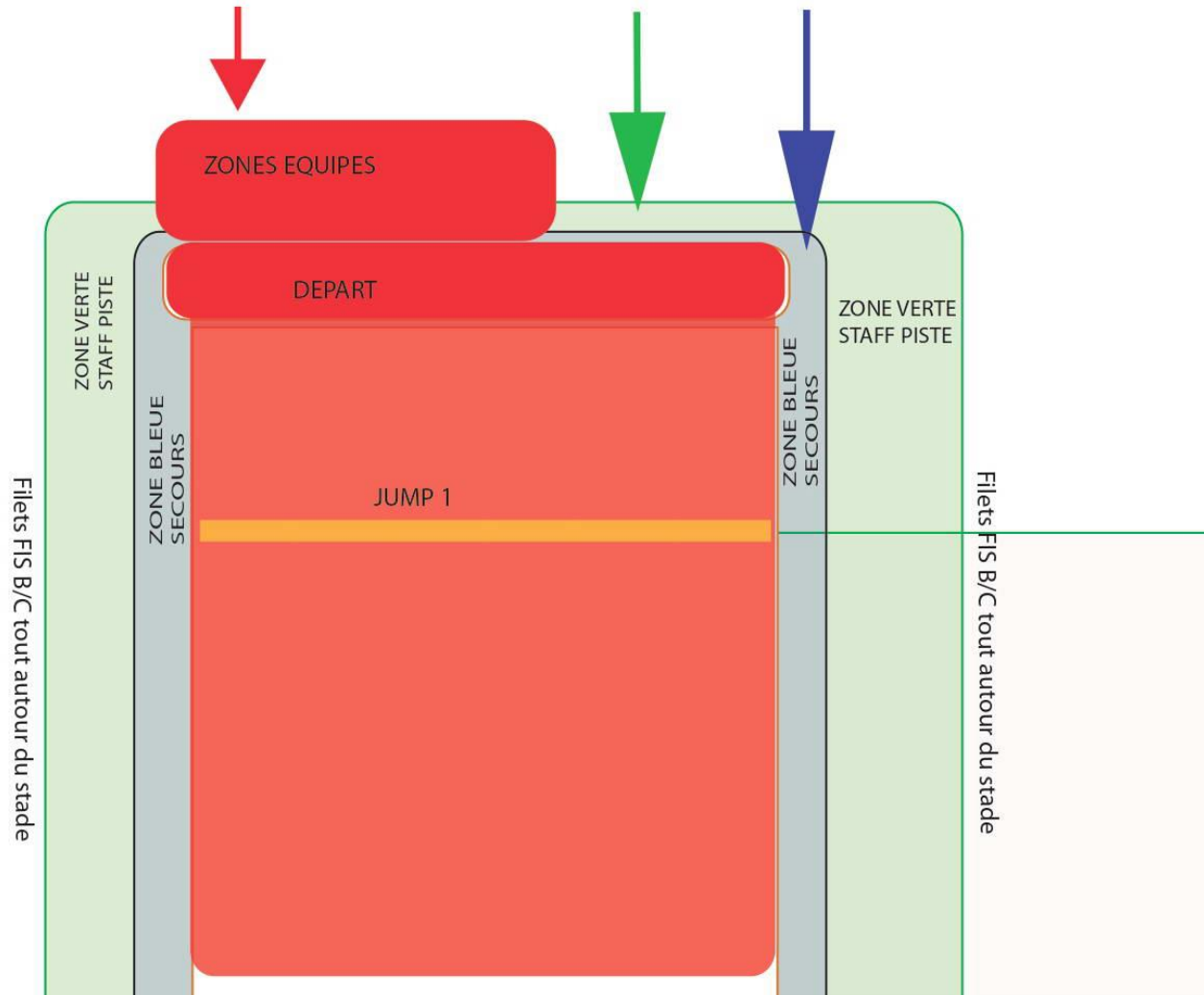

Race Bubble

Organization Bubble

Slope Staff Bubble

Press Bubble

SANITARY MEASURES BY ZONE

FINISH

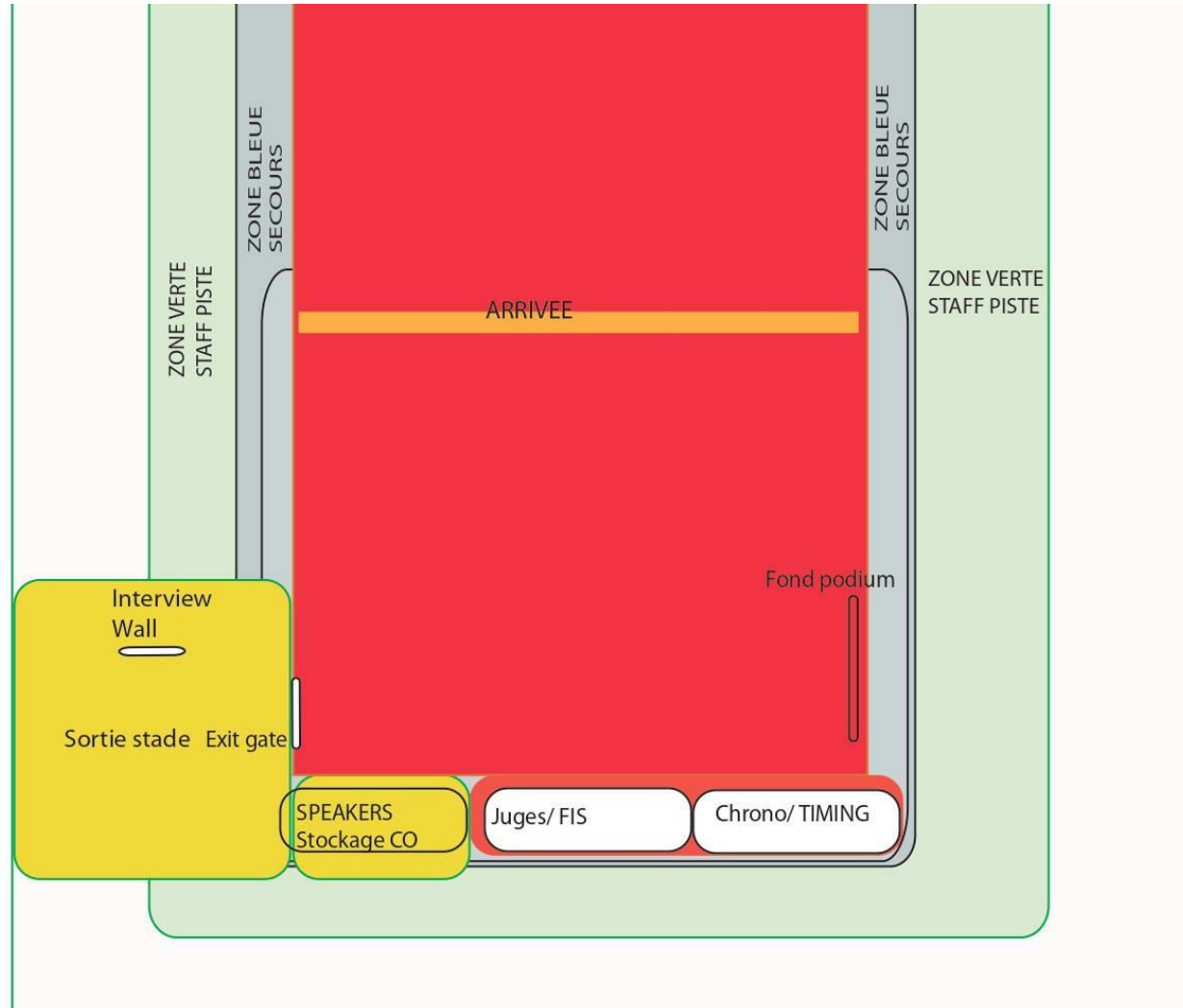

Race Bubble

Organization Bubble

Slope Staff Bubble

Press Bubble

SANITARY MEASURES BY ZONE

ANTI-DOPING

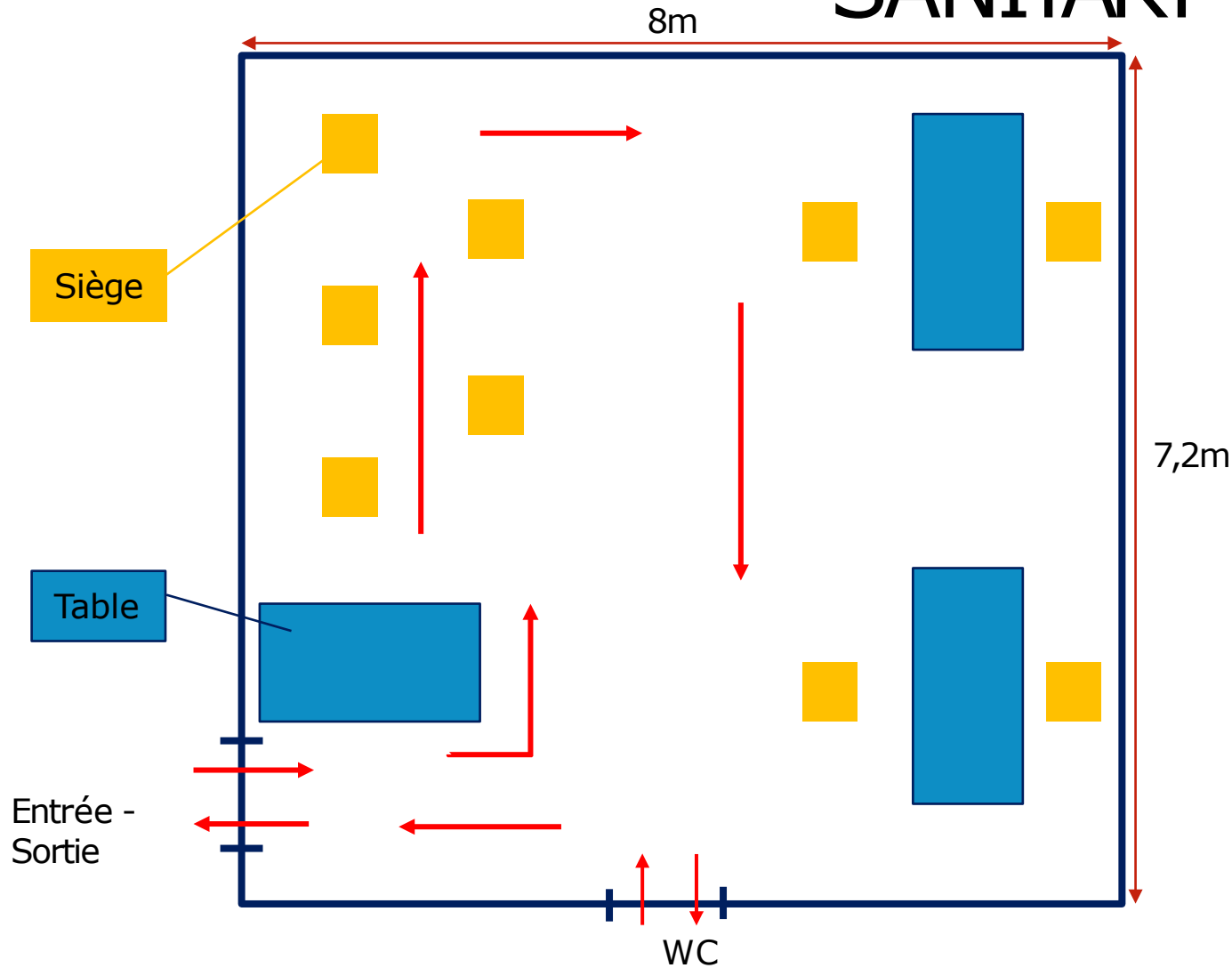

Race Bubble only

SANITARY MEASURES BY ZONE

TCM

In agreement with the race director, the race committees will be made by videoconference to limit interactions

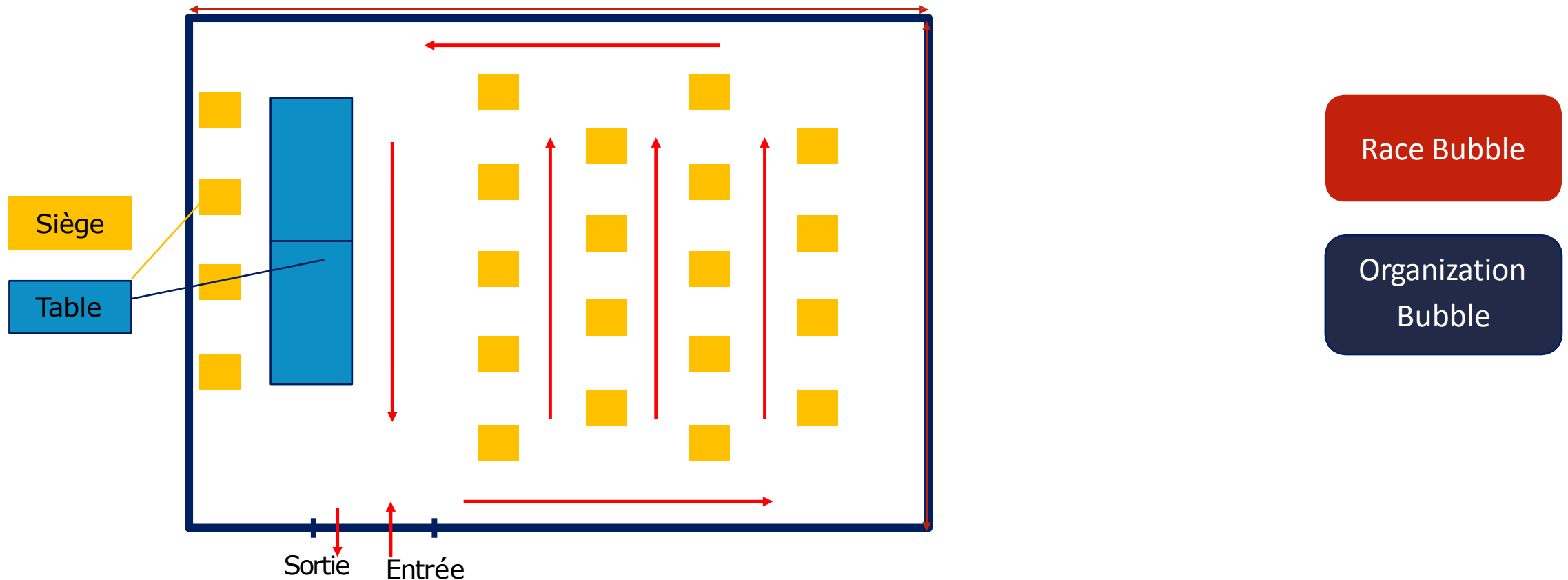

SANITARY MEASURES BY ZONE

OFFICIAL AWARDS CEREMONIES

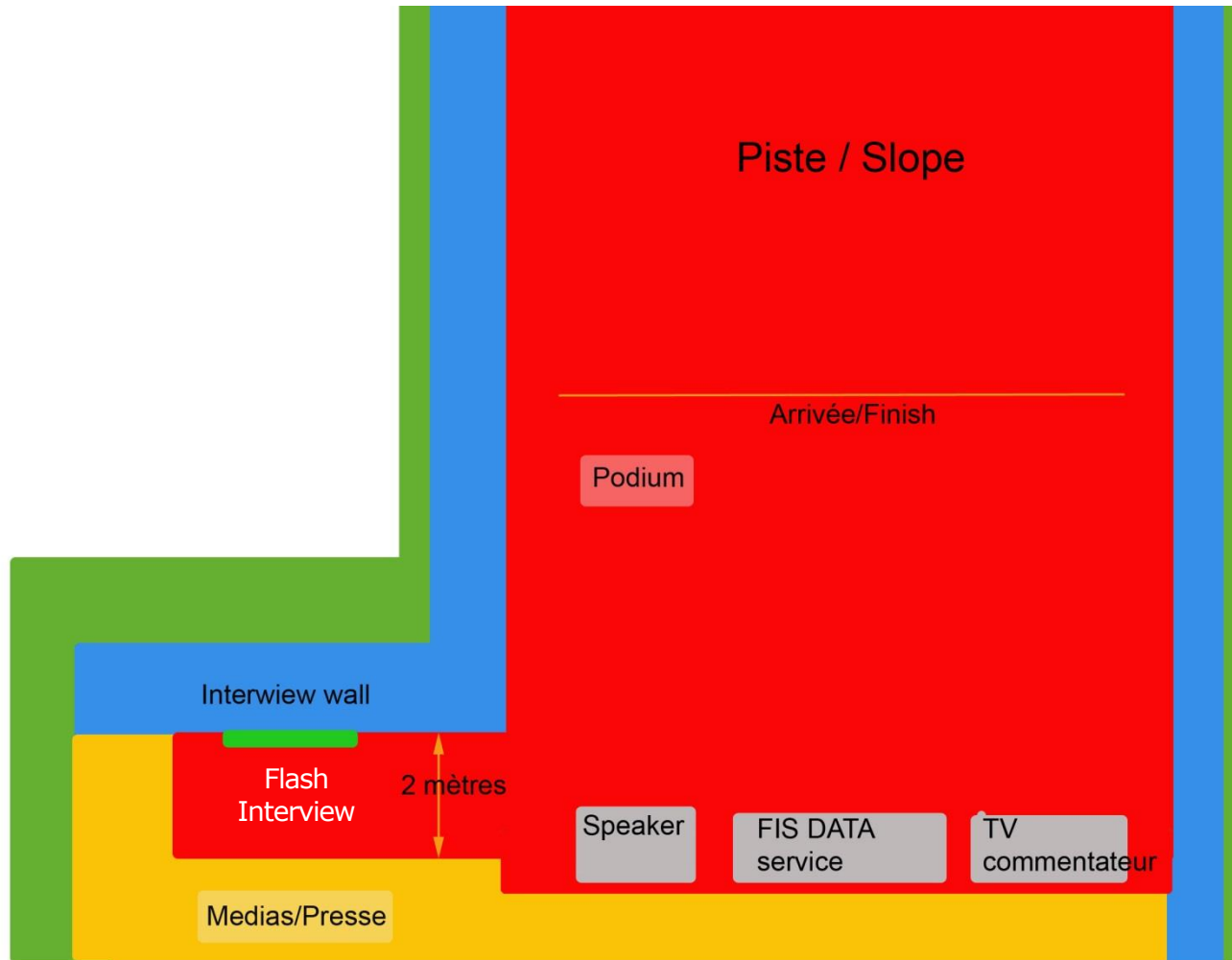

- Contact FIS COVID :
- Email : c19support@fisski.com

- Contact Local des Coordinateurs COVID:
- **Dr Delphine Bourez** +33 662614006
- delphine.bourez@gmail.com

BRETON Yves & PRIBISE Maud ski club Alpe d'Huez

- Phone Yves : +33 646.42.77.90
- Phone Maud : +33 476.80.34.42

alpedhuezskiclub@gmail.com

- Contact race director FIS :
- RINALDI Andrea
- Phone : +41.79.421.44.21

Hospitals

Hôpital de Grenoble (CHU)

Hôpital « Nord » : bd Chantourne 38700 LA TRONCHE Tél : + 33 4 76 76 75 75

Hôpital « Sud » : avenue de Kimberley 38400 ECHIROLLES Tél : +33 4 76 76 75 75

Cabinets médicaux à l'Alpe d'Huez :

GRUPE MEDICAL DE LA MEIJE - Centre médical niveau 1

Dr Achkar Brigitte et Dr Girault Coralie

Route du Signal 38750 L'ALPE d'HUEZ

Tél : +33 4 76 80 37 30

CABINET MEDICAL DES BERGERS - Centre médical niveau 1

Dr Robert

Centre commercial des Bergers 38750 L'Alpe d'Huez

Tél : +33 4 76 80 69 29

Pharmacists à l'Alpe d'Huez

Pharmacie des Jeux

Avenue des Jeux 38750 L'ALPE D'HUEZ

Tél : 04 76 80 31 73

Pharmacie des Bergers

Centre Commercial Les Bergers, Avenue des Marmottes, 38750 Alpe d'Huez

Tél : 04 76 80 33 47