

FIS Moguls & Dual Moguls World Cup Final

From 15th to 19th march 2022



Health Protocol COVID-19

Measures & rules published by the organization
in collaboration with the FFS& FS





THE HEALTH PROTOCOL

- This guide was created by the French Ski Federation (FFS) and the Local Organizing Committee (LOC) of Megève and has been validated by the International Ski Federation (FIS), in compliance with the [FIS Covid-19 guide](#). This will be communicated to all participants in advance of the event.
- It is everyone's responsibility to follow the protocol put in place for the FIS Moguls & Dual Moguls World Cup Final in Megève. If this is not followed, the person concerned will not be able to stay on the event.
- The principles, to date :
 - **Interactions limitation** through sanitary bubbles
 - An airtight racing bubble with very strict protocols
 - Respect for physical distancing and barrier gestures in all areas
 - **Wearing a mask** is mandatory in all interior and exterior areas
 - **A policy of nasopharyngeal or antigenic RT-PCR virological tests** and a **health questionnaire** has been set up for the races, organization and press bubbles





THE SANITARY BUBBLES

In order to facilitate traffic flow and avoid any contact between the various people present, a system of accreditation and access zones by color has been set up.

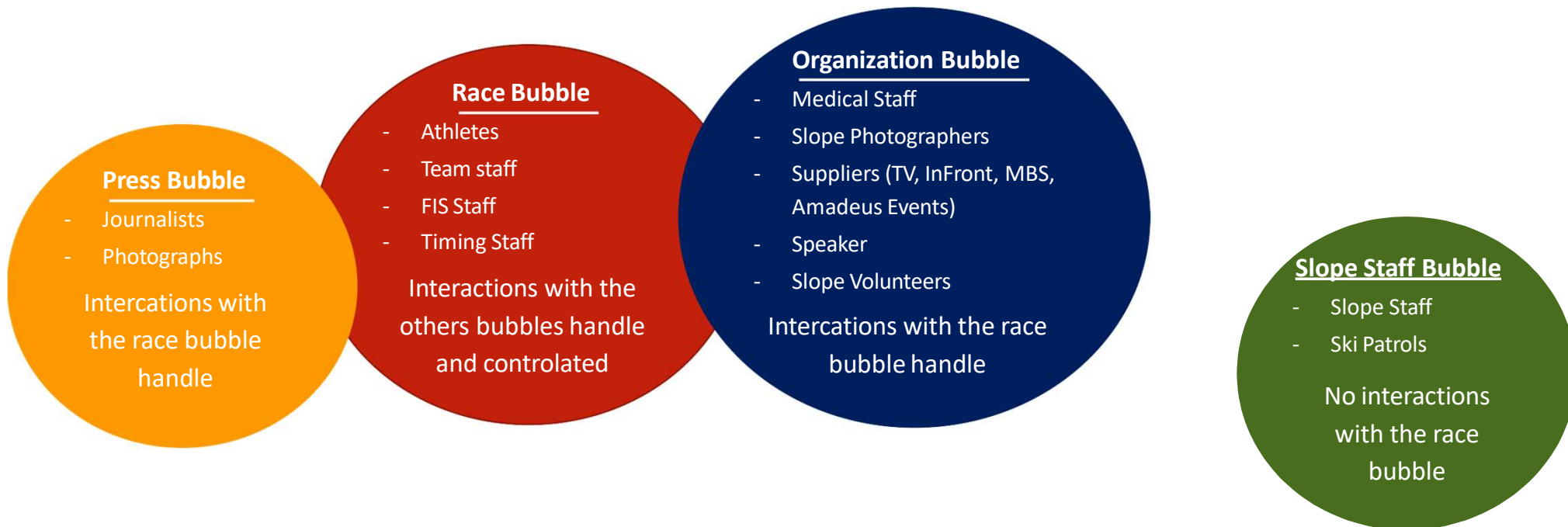



TESTS POLICY

- Strict compliance with the Ministry of Health and the ARS rules
- To be accredited, you must to present :

RACE BUBBLE

- Valid European Sanitary Pass
- A nasopharyngeal or antigenic RT-PCR test has to be done less than 48h before the start of the competition
- Obligation to present the completed and signed FIS questionnaire
- **Please complete the FIS passport**
-> <https://fispasport.fisiski.com/fis/>

RACE ORGANIZATION & PRESS BUBBLE

- Valid European Sanitary Pass
- Result of :
 - a nasopharyngeal RT-PCR or antigen test < 0, less than 48 hours before the start of the event.
 - Or an RT-PCR or antigen test >0, dated less than 6 months and more than 2 weeks
- Obligation to present the completed and signed FIS questionnaire

ORGANIZATION, SLOPE STAFF, VIP & PUBLIC BUBBLE

- Valid European Sanitary Pass

- During the race, you can contact the medical center of Megève or pharmacy of Megève for doing a RT-PCR (results in 24h) or antigen tests (results on 15min)
- SANITARY PASS = Vaccines (**Pfizer, Moderna, AstraZeneca, Vaxzevria, Covishield or Johnson & Johnson**) or an RT-PCR or antigen test >0, dated less than 6 months and more than 2 weeks
- After the race, Contact the coordinating doctor of Megève for any occurrence of symptoms within 7 days of the Moguls & Dual Moguls Ski World Cup



PREVENTION DEVICE

- Disinfection solutions in all key places
- The masks or approved buff obligatory (depending of national norm and/or signage in place)
- All working areas should be disinfected and cleaned (TCM Room, Team Area, VIP Space, Press Room, etc...)
- Distanciation requested
- Limited number of people per zone
- Reminders for athletes and spectators: main competition speaker, information, posters, team captains meeting, etc...
- LOC will be always in communication with the medical center of Megève.
- The LOC recommends that you to download the « TousAntiCovid » application



SANITARY MEASURES

OBJECTIVE & BASIC PRINCIPLES

Preserve the health of the athletes and all those involved in the event as well as the continuity of the races.



PROTECTION

Mandatory mask wearing
Regular use of hydroalcoholic gel

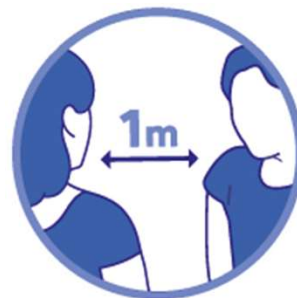

DISTANCING

Respect for social distancing



SECURITY

No interaction with the public (autographs and selfies are strictly prohibited)



SANITARY MEASURES

OBJECTIVE & BASIC PRINCIPLES



SCREENING

Subscribe to the Covid-19 testing policy Presented above, and in conjunction with the Ministry of Health



CONFINEMENT

Respect your family and have no contact other than those planned and secure



TRANSPARENCY

Report all symptoms to doctors and organisation
Identify contacts at risk



VENTILATION

Ventilated spaces



SANITARY MEASURES

BREACH OF HEALTH PROTOCOL





SANITARY MEASURES

- ✓ Verification of the sanitary pass and the access control according to the accreditation colors will be done at the entrance of the event.
- ✓ The spaces will be reorganized in order to limit the flow of people
- ✓ Limit the workforce within the spaces

Lift Access :

- ✓ Specific queue for the race bubble
- ✓ Respect for the national laws in place during the event : [See the ski lifts' rules](#)





SANITARY MEASURES

Podiums :

- ✓ Prize giving at the end of the races on the finish area
- ✓ Respect for physical distancing between the athletes themselves and between athletes and journalists
- ✓ A space will be reserved for photographers and journalists in front of the podium at a suitable distance
- ✓ No handshaking
- ✓ Athletes must stay on their podium

Media :

- ✓ Media will not be able to have direct access to athletes, competition areas or team zones.
Concerning the athletes' interviews, media should do it from the Mixed Zone (through the safety area)
- ✓ It is recommended that journalists invest in a 'selfie stick' or boom stick to get the recording device close enough to pick up the athlete's voice during mixed zone interviews.
- ✓ All microphones should have a plastic cover over the foam that is replaced after each interview. The microphone should stay only with the athlete and the journalist should not speak into it as well





F I S **FREESTYLE SKI
WORLD CUP**



SANITARY MEASURES BY ZONE

FLOW PLAN

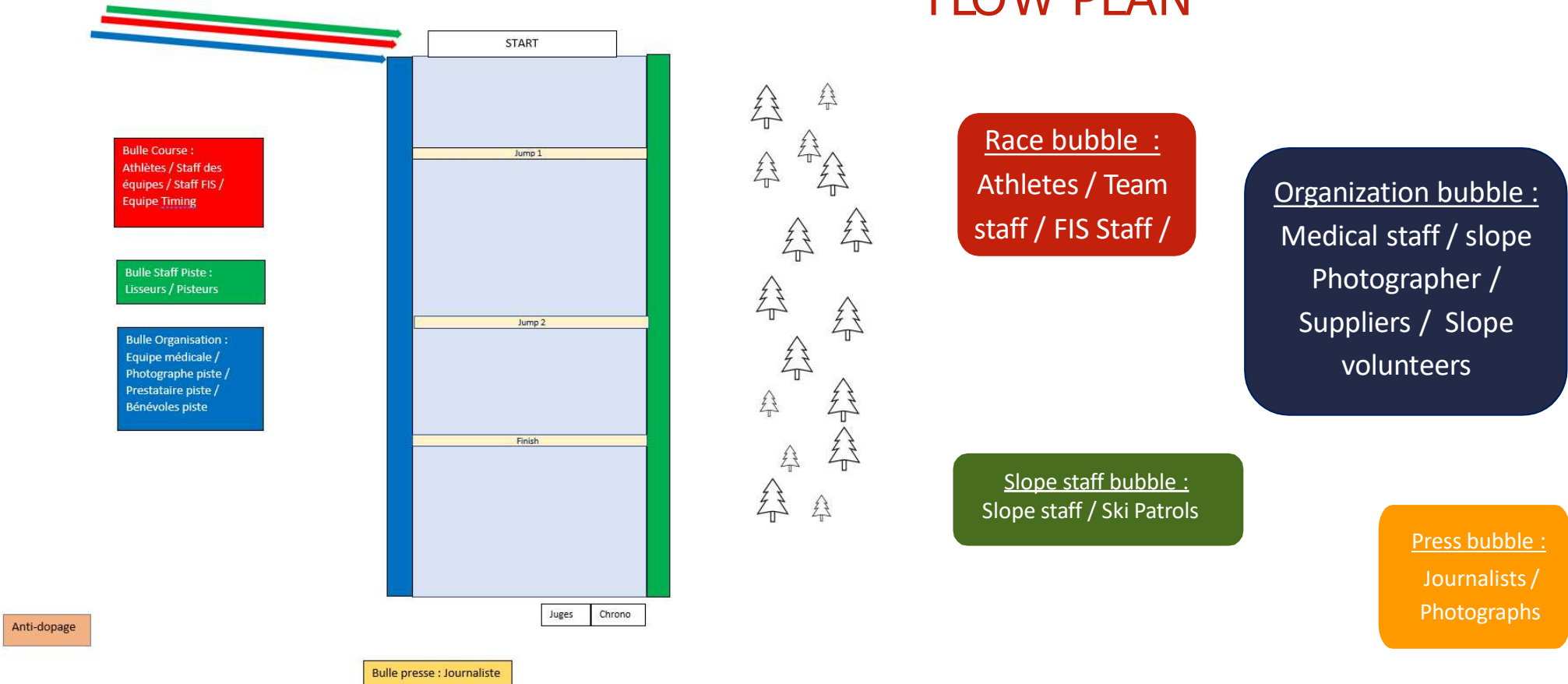



SANITARY MEASURES BY ZONE

START

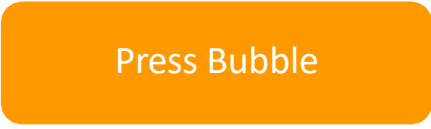
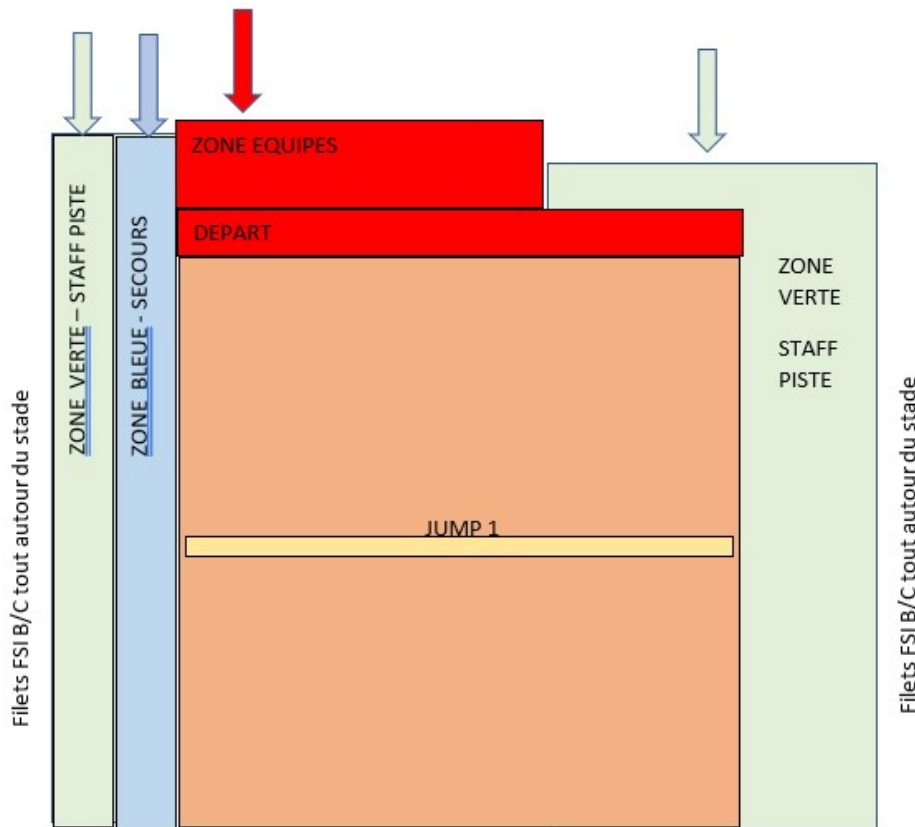



SANITARY MEASURES BY ZONE

FINISH

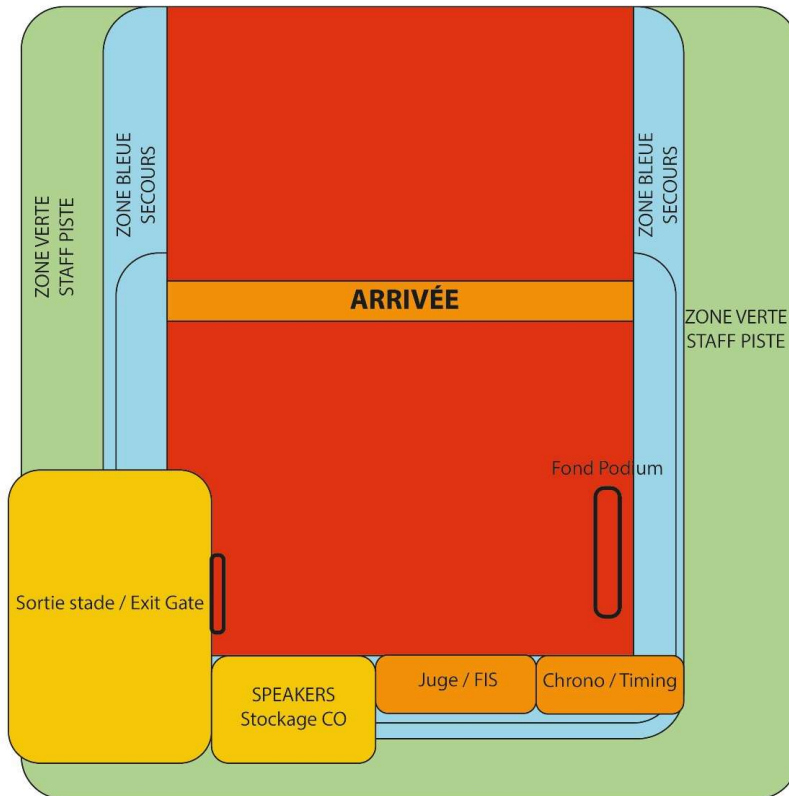

Race Bubble

Organization Bubble

Slope Staff Bubble

Press Bubble



SANITARY MEASURES BY ZONE ANTI-DOPING

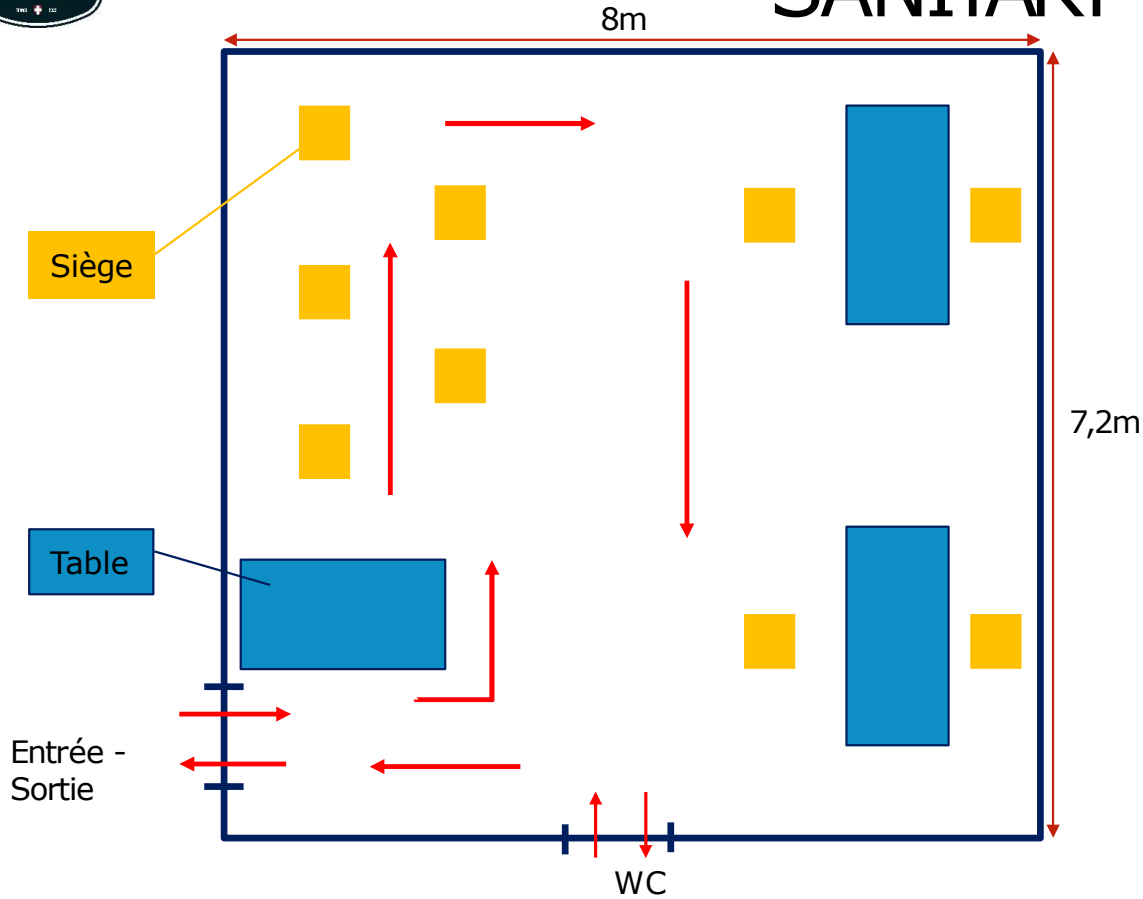

Race Bubble only



SANITARY MEASURES BY ZONE

TCM

In agreement with the race director, the race committees will be made by videoconference to limit interactions.

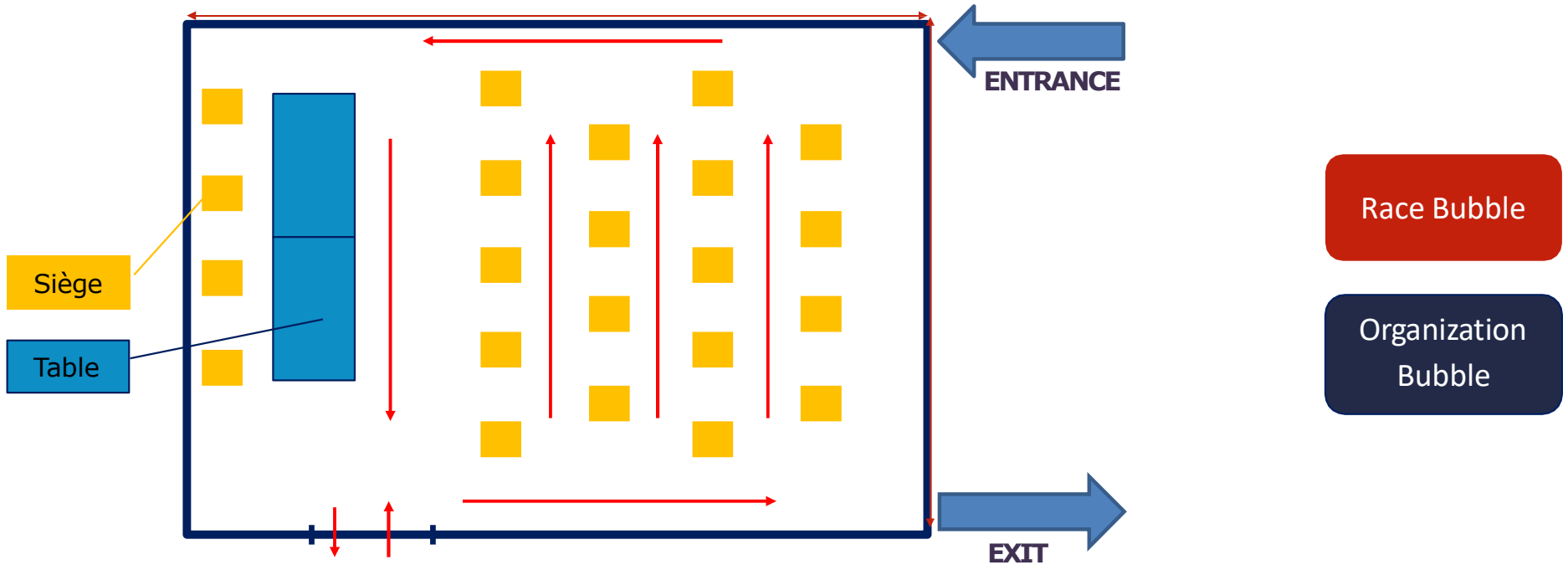



LES MESURES SANITAIRES

OFFICIAL AWARDS CEREMONIES

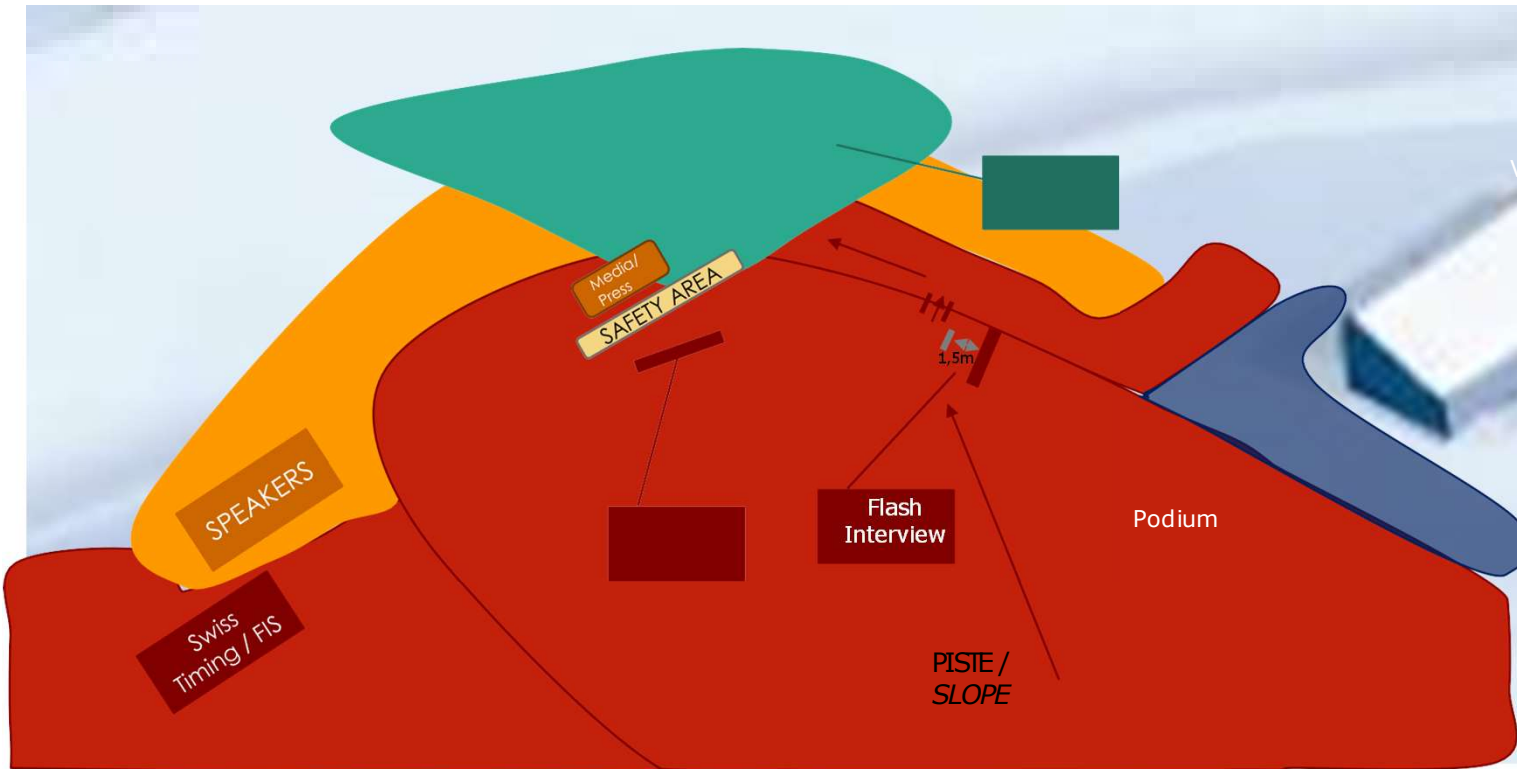



CONTACTS

✓ **Contact FIS COVID :**

Email : c19support@fisski.com

✓ **Contact Local Coordinators COVID :**

Fabienne & Yolène : +33.450.213.150

E-mail : contact@csmegeve.com

✓ **Club des Sports de Megève :**

+33.450.213.150

contact@csmegeve.com

✓ **Contact Race Director Moguls :**

Andrea RINALDI

Phone : +41 79 421 44 21

Médical Center of Megève :

Phone : +33.450.587.474

Adress : 11 Rte du Villaret, 74120 MEGEVE

Tous les jours : 9am – 7pm

Mirialis laboratory of Megève:

Phone : +33.450.212.995

Adress : 11 route du Villaret – 74120 MEGEVE

Du lundi au Vendredi : 7.30am – 12am